



Clip Loc ROOF SYSTEM

Details and Installation Guide

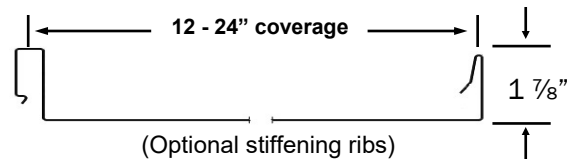

TABLE OF CONTENTS

<u>Page</u>	<u>Descriptions</u>
3	Designer / Installer Notes
4	Hem Lengths
4	Thermal Movement Table
5	ClipLoc Installation
6	Eave Trim Detail
7	Eave with Gutter Detail
8	W Valley Detail
9	Sidewall Detail
10	Endwall Detail
11	Gable Trim Detail
12	Non-Vented Ridge Cap
13	Vented Ridge Cap
14	Top Shed Flashing
15	Vent Pipe Details
16	Clip Loc End-lap Detail
17	Parapet Cap
18	Cricket Application
19	Skylight Flashing Details
20	Skylight Flashing Details (Cont.)
21	Take-Off Appendix
22, 23	Panel Cut-Sheet
24	Contact Us

DESIGNER / INSTALLER NOTES

This guide is supplied by Metallion Industries for use by its customers and should be read in its entirety before beginning installation. These instructions do not replace or supersede local or state building codes, and do not portray all situations or projects. Installation methods may vary and are the responsibility of the designer/user. Climate conditions such as wind, snow, and proximity to salt air conditions must be taken into account, along with the intended use and maintenance of the structure. Contact your contractor, architect, or local building department for further assistance if needed.

Substrate

Clip Loc can be installed over solid substrate, open purlins, metal decking, or rigid insulation. Contact a Metallion Industries representative for spacing requirements on open purlins. Where panels are installed over Rigid Insulation/Steel Deck, the use of a base plate under the clip is required.

Underlayment

Felt paper, certain types of synthetic underlayment, or ice and water shield are acceptable underlayments. Heavy snow loads, freezing conditions, or proximity to the ocean may involve specific requirements. Follow the underlayment manufacturers' recommendations for installation.

Expansion and Contraction

Clip Loc panels utilize a clip that allows the panel to expand and contract with changes in temperature, which is especially important on long panel lengths. Typically, Clip Loc panels are fastened at the ridge and allowed to slide at the eave edge. The overlap of the hemmed panel and the hidden cleat may need to be increased to accommodate thermal movement.

Oil Canning

In certain conditions, panels may show slight waviness commonly referred to as "oil canning." This can occur as a result of the roll-forming process, or it may be simply telegraphing whatever the underlayment is. Oil-canning does not affect the structural performance of the roof system, and is not cause for rejection of the material. Although "oil canning" with steel cannot be 100% eliminated, a flat underlayment will greatly reduce the possibility.

Handling and Storage

Handle the Clip Loc panels with care - it may be necessary to use a spreader bar with a crane or forklift if the panels are long. Reckless maneuvering or too much handling and moving can cause the panels to rub against each other and mar the painted surface.

Store the panels and other materials in a dry, well ventilated area, away from traffic. Place bundle on blocks and elevate one end of the bundle so that any moisture that may have accumulated can then run off. If outdoor storage cannot be avoided, protect the metal with a breathable canvas or waterproof paper cover. Leave the bottom of the cover loose to allow air circulation. Do not use plastic which causes sweating or condensation.

Maintenance

If you have a low pitch roof and/or valleys, you may need to remove debris or residue from the roof to prevent the trapping of moisture against the metal. Some flashings may need to be re-sealed periodically in order to maintain optimum weather-tightness. If you need to wash the roof, you can use a pressure washer and/or use a mixture of one cup detergent (containing less than .5% phosphate) mixed with five gallons of warm water. Another mixture could be one cup of household ammonia mixed with five gallons of warm water. Wear clean, non-marking, soft soled shoes when walking on the panels to avoid shoe marks or damage to the finish.

Safety

Wear proper clothing, eye protection, and gloves when working with sheet metal. Follow all OSHA safety requirements. Metallion Industries will not assume any responsibility for personal injury, property damage, or other problems which may result from improper installation or other usage of the products. SMACNA (Sheet Metal and Air Conditioning Contractors National Association) architectural sheet metal manual specifications shall govern for material and workmanship not shown.

The specifications and drawings in this manual are subject to change without notice or obligation to make changes in products previously purchased.

HEM LENGTHS

Changes in temperature cause metal roofing to expand with high temperatures and contract with cold temperatures. To keep the panel where it belongs, one end is fastened to the substrate and the other end is allowed to move. The panel end that is allowed to move is usually hemmed around a cleat which is fastened to the substrate. This allows the panel to expand and contract while ensuring weathertightness. The required length of the hem is determined by several factors.

Unless a more exact analysis of the temperature during installation compared to the anticipated temperature range is conducted, use the following equation and the Thermal Movement Table. When installing panels, be sure to leave room at the end of the panel that will experience movement for the “starting gap” which is the required air space (X) between the panel and cleat. For example, when installing a 50’ steel panel over a wood substrate, calculate $2 \times 3/8" + 1/4" = 1"$ overall hem length. Make sure to not install the hem tight against the cleat, especially in hot weather, and that the back edge of the hem will not touch any flashings when the panels contract in cold temperatures.

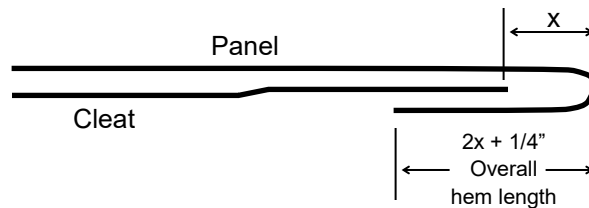

Thermal Movement Table

Panel movement with temperature change of 100°F for the panel and
50° for the substrate

PANEL MATERIAL	SUBSTRATE MATERIAL	PANEL LENGTH (FT.)			REQUIRED AIR SPACE (X)
		10'	50'	100'	
Steel	Rigid insulation	1/8"	1/2"	7/8"	
	Wood	1/16"	3/8"	5/8"	
	Steel	1/16"	3/8"	5/8"	
	Concrete	1/16"	3/8"	1/2"	
Aluminum	Rigid insulation	3/16"	7/8"	1 9/16"	
	Wood	3/16"	11/16"	1 3/8"	
	Steel	1/8"	5/8"	1 3/16"	
	Concrete	1/8"	5/8"	1 1/4"	

Clip Loc Installation

Prior to installation of the panels, any flashing going underneath the panel should be installed. Panels should be started opposite from the direction of prevailing winds. To begin, place an alignment line along the gable end where the first roof panel will be installed. This line should be located 1/2" in from the gable edge of the roof deck and square with the eave line. Caution must be taken to insure that the panels are kept in square as they are installed. Regarding overhang at the eave edge: depending on the pitch of the roof, the use or absence of gutters and other circumstances, we recommend an overhang anywhere from 1/2" to 2".

The Clip Loc panel is fastened to the roof via clips. Two styles of clips are available. A clip with a 3 1/2" base is used for fastening to steel purlins. A clip with a 2 1/2" base is used for fastening to plywood decking. When fastening to steel purlins, place one clip on every purlin and fasten with low profile tek drillers. When fastening to plywood decking, space clips every 2' and fasten with low profile wood screws.

Eave Trim

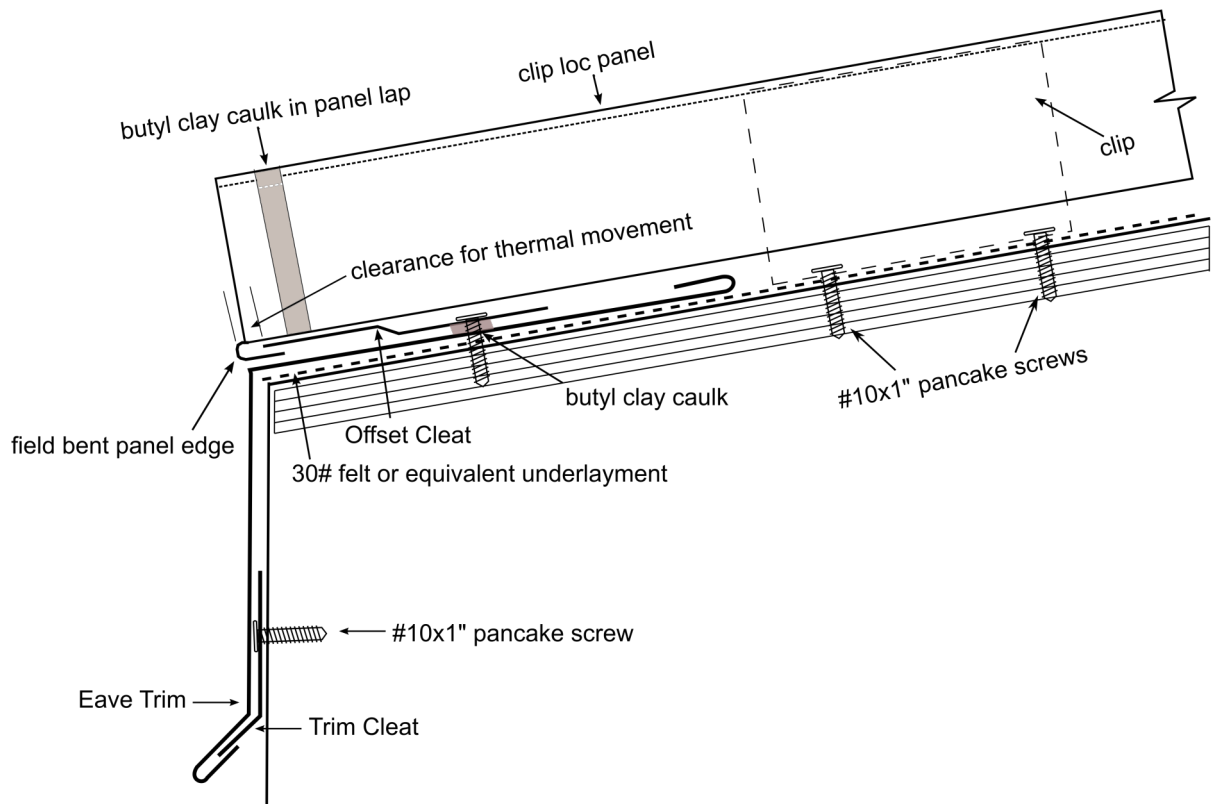

Notes:

1. Install underlayment on roof.
2. Install trim cleat.
3. Install eave trim, hooking onto trim cleat.
4. Install offset cleat. Run butyl clay between offset cleat and eave trim, fastening through with #10x1" pancake screws every 12"-18" OC.
5. Install roof panels. Cut ribs back and bend end of panel around offset cleat.

Option 2:

In lieu of the cleat system at the end of the panel, run butyl clay between panels and eave trim. Through fasten the end of each panel with 3 grommeted screws.

Trim Cleat

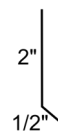

Offset Cleat

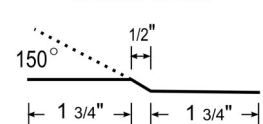

Eave Trim

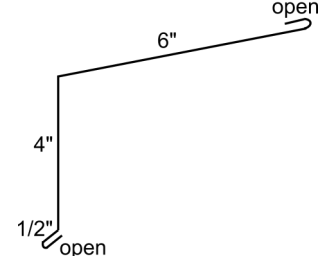

Eave With Gutter

Residential

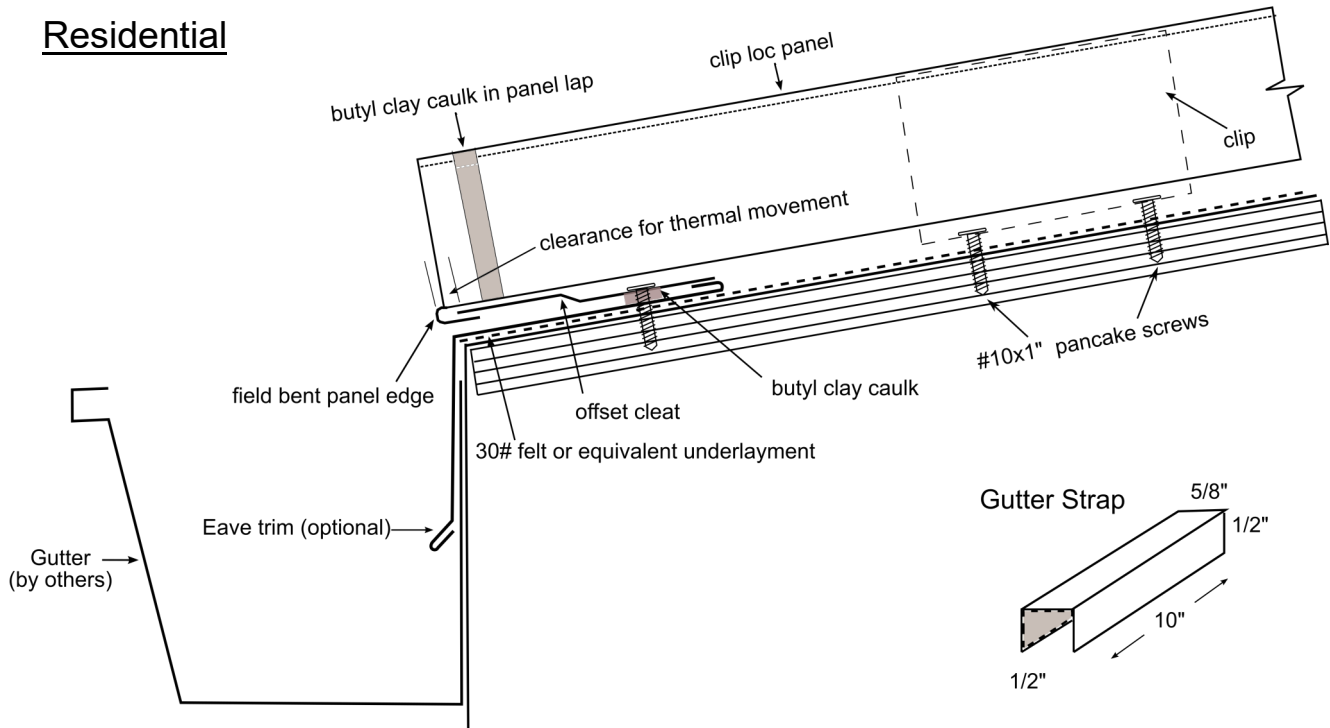

Notes:

For Commercial Application

1. Install eave trim over siding.
2. Install roof panels over eave trim. Seal with butyl clay. Fasten through butyl clay.
3. Install gutter. Fasten flat of roof panel to inside flange of gutter, using 2 stitch screws per panel.
4. Install gutter strap on every other rib (3' spacing). Using three stitch screws, fasten gutter strap under outer flange of gutter and over rib of panel.

Commercial

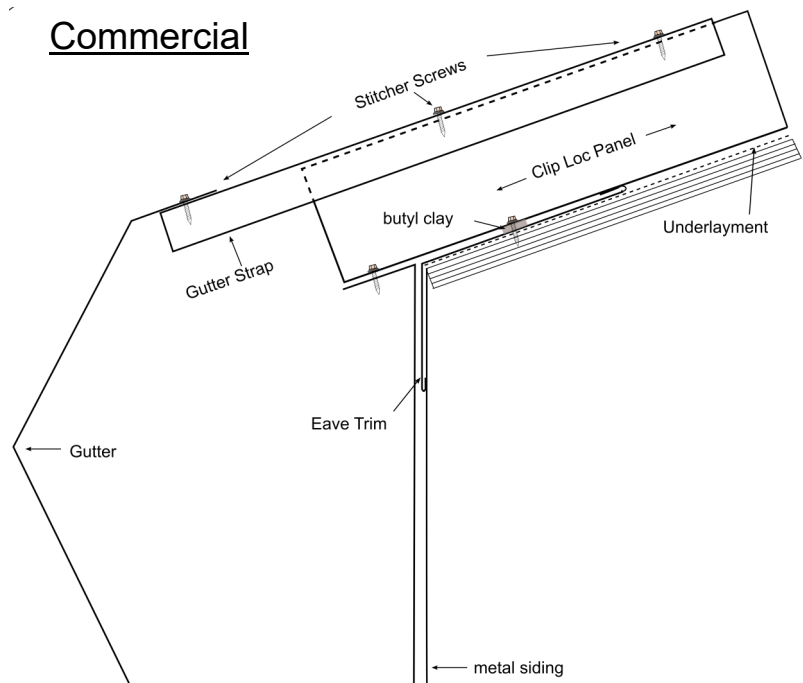

W Valley

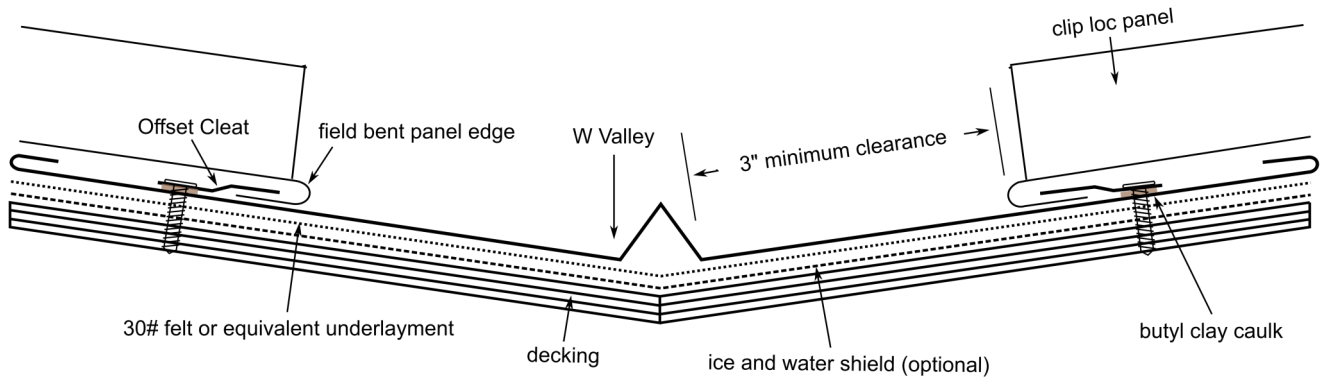

Notes:

1. Install underlayment.
2. Fasten W Valley in place every 12"-16" O.C.
3. Install offset cleats, bedded in butyl clay.
4. Install roof panels. Cut ribs back, and bend panel ends around offset cleat.

Option 2:

In lieu of the cleat system at the end of the panel, run butyl clay between panels and W valley. Through fasten the end of each panel with 3 grommeted screws.

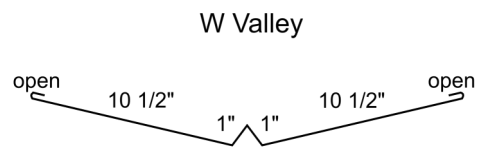
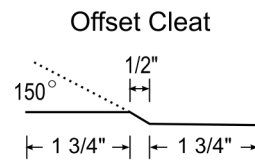

Sidewall Trim

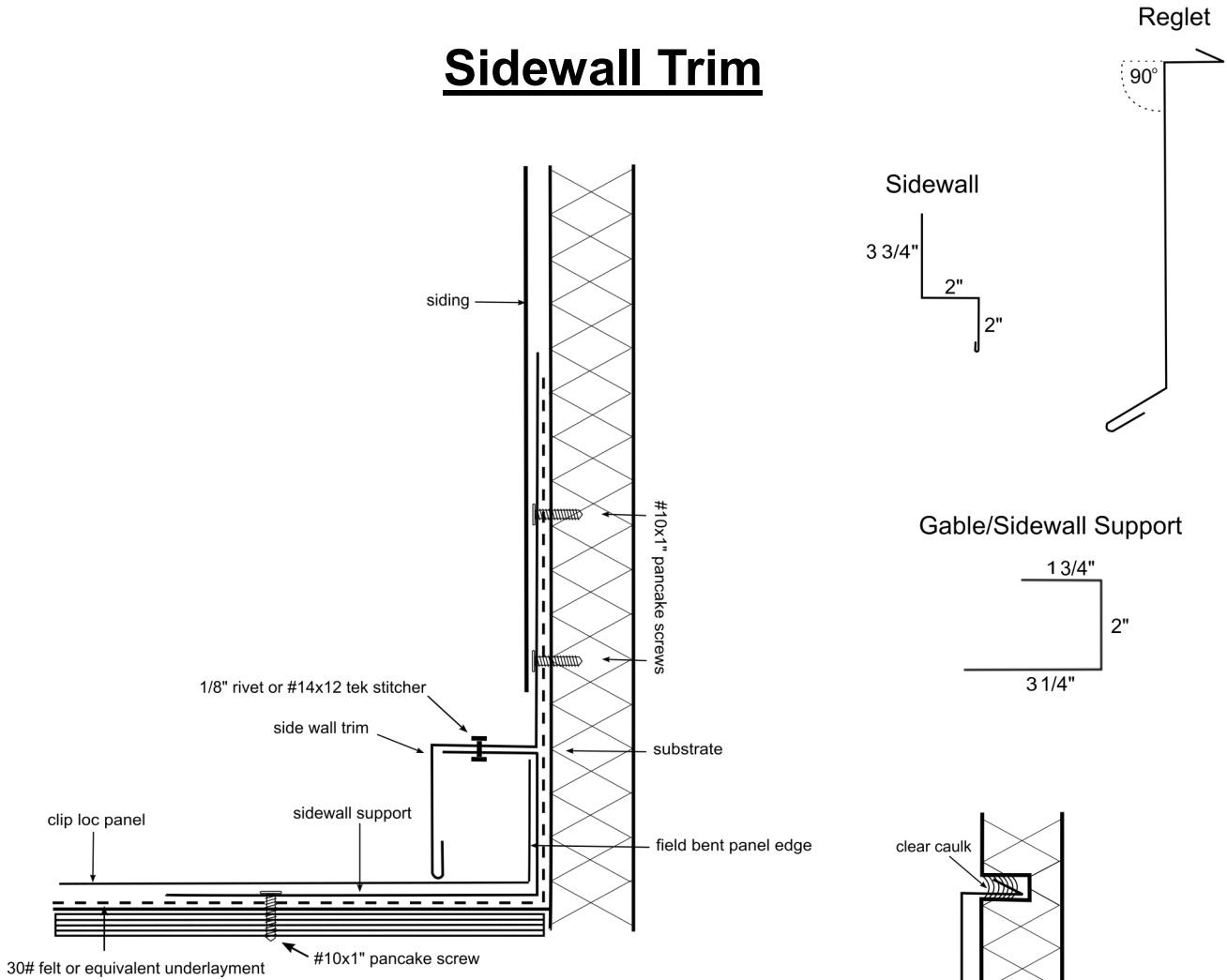

Notes:

1. Install sidewall support. Install roof panels with the rib or field bent panel edge inserted into the sidewall support.
2. Install sidewall trim over sidewall support. Fasten as needed.
3. For masonry application: Install reglet over fastened sidewall trim. Insert top end of reglet into channel cut in masonry wall. Seal with clear caulk.

Masonry Application

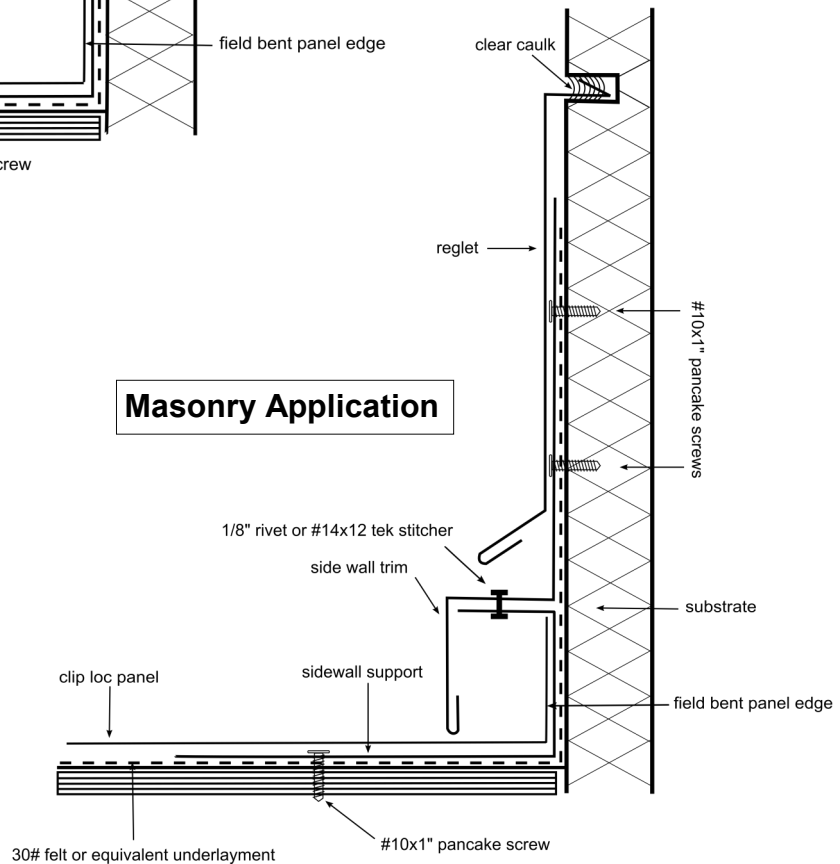

Endwall Trim

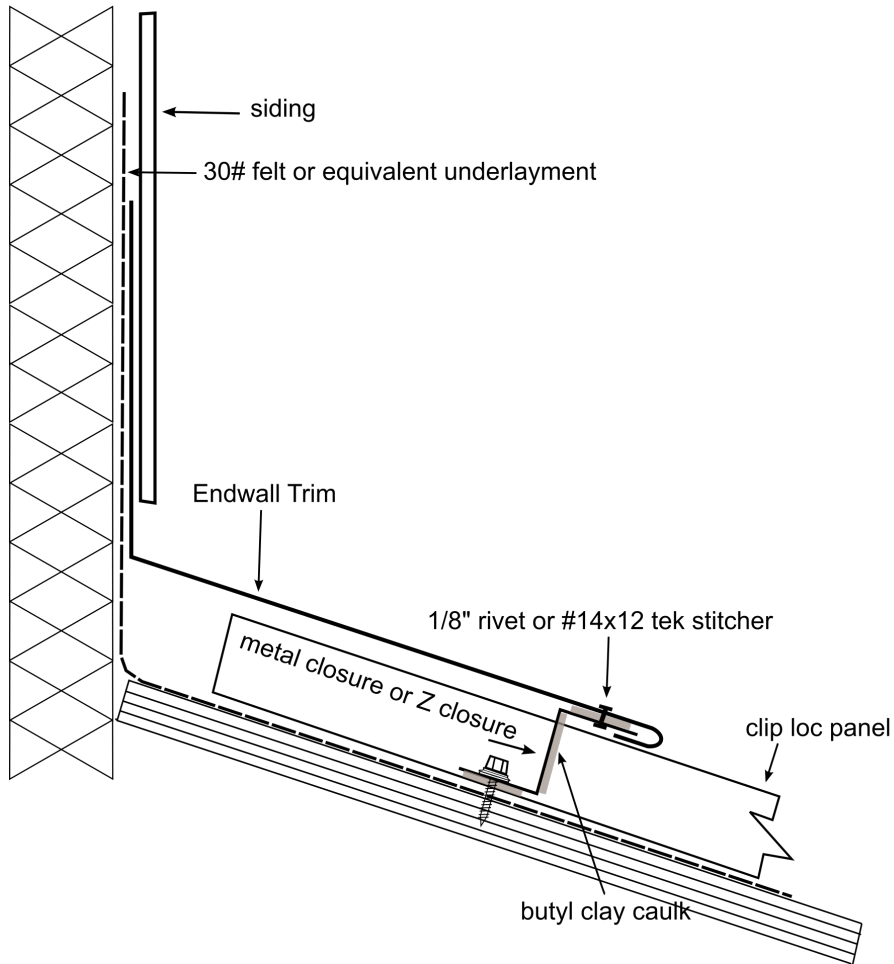

Notes:

1. Install roof panels.
2. Install metal closures, bedded in butyl clay on three sides. Fasten with 4 screws per metal closure.
3. (Opt.) In place of metal closures, install z closure, bedded in butyl clay on three sides, notching to fit over panel rib.
4. Install endwall trim.

Z Closure

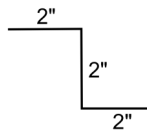

Metal Closure

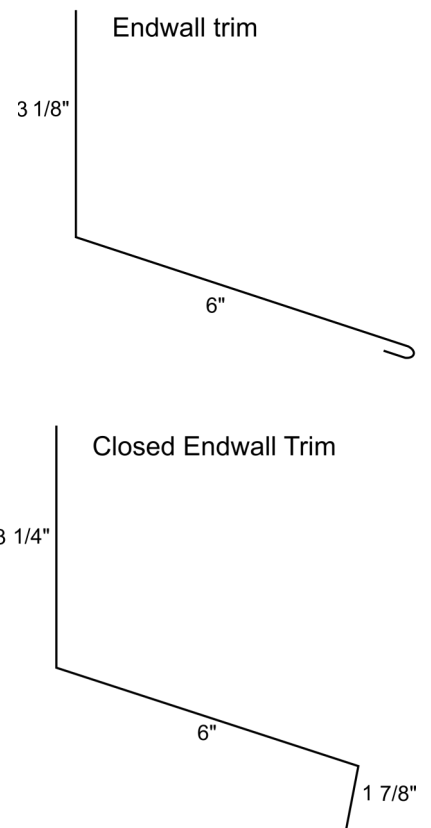
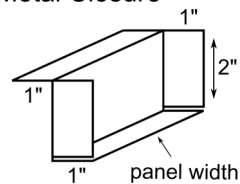

Gable Trim and Last Panel Termination

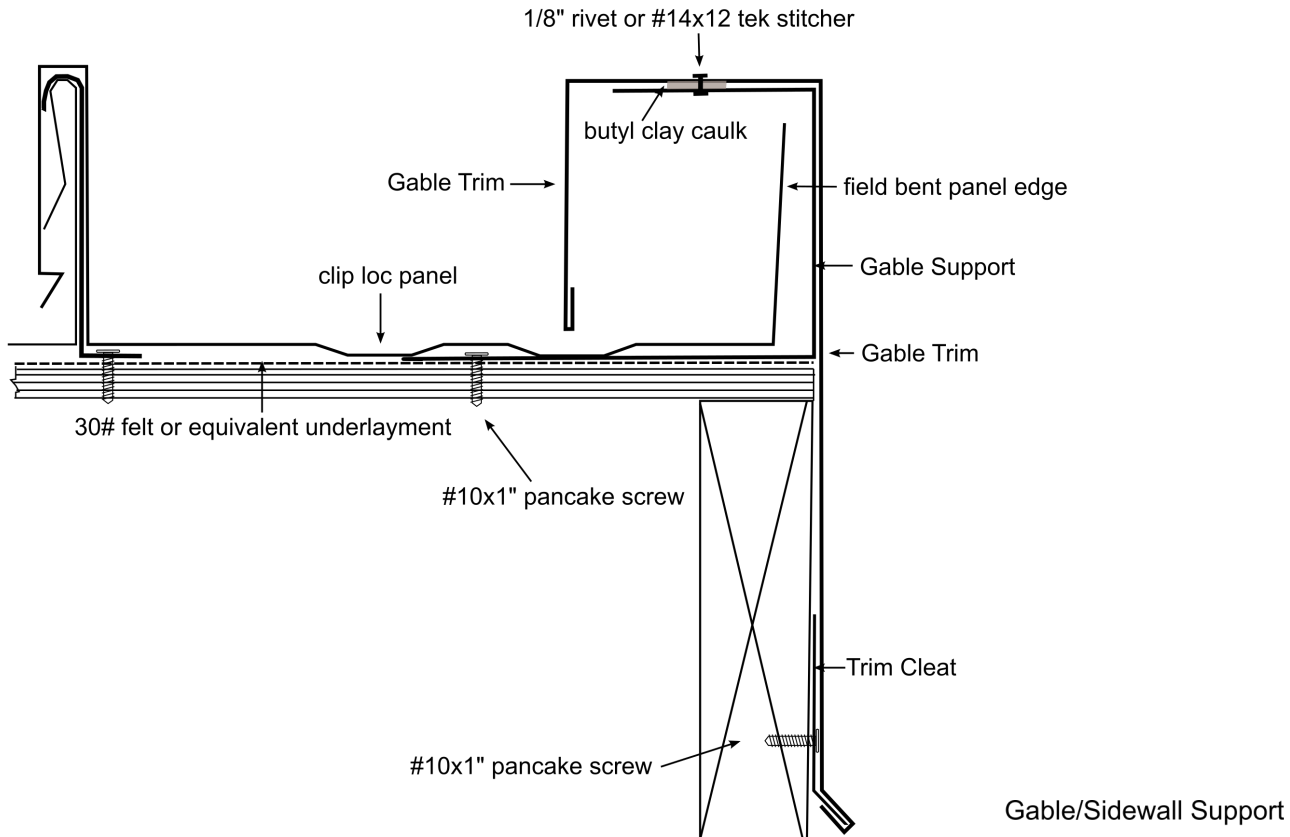

Notes:

1. Install gable support trim. Fasten every 12"-18" OC.
2. Install roof panels. Cut last panel 1 3/4" past the edge of the roof and bend up 90° to fit inside gable support.
3. Install trim cleat. Fasten every 12"-18" OC
4. Install gable trim over gable support and fit around trim cleat. Run continuous butyl clay between gable support and gable trim. Fasten gable trim to gable support with 1/8" rivet or #14x12 tek stitcher.

Trim Cleat



Gable/Sidewall Support

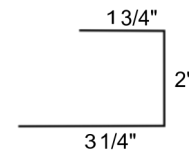

Sculptured Gable Trim

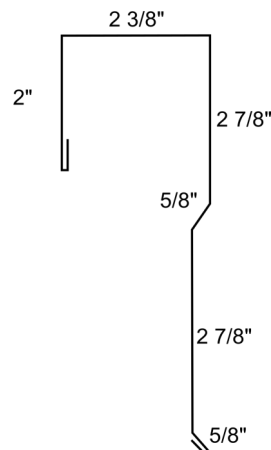

Gable Trim

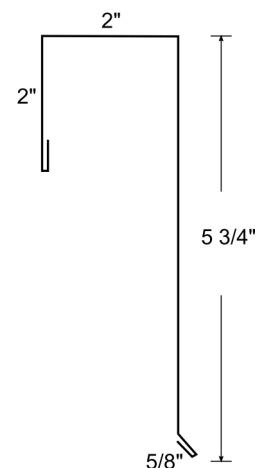

Non-Vented Ridge Cap

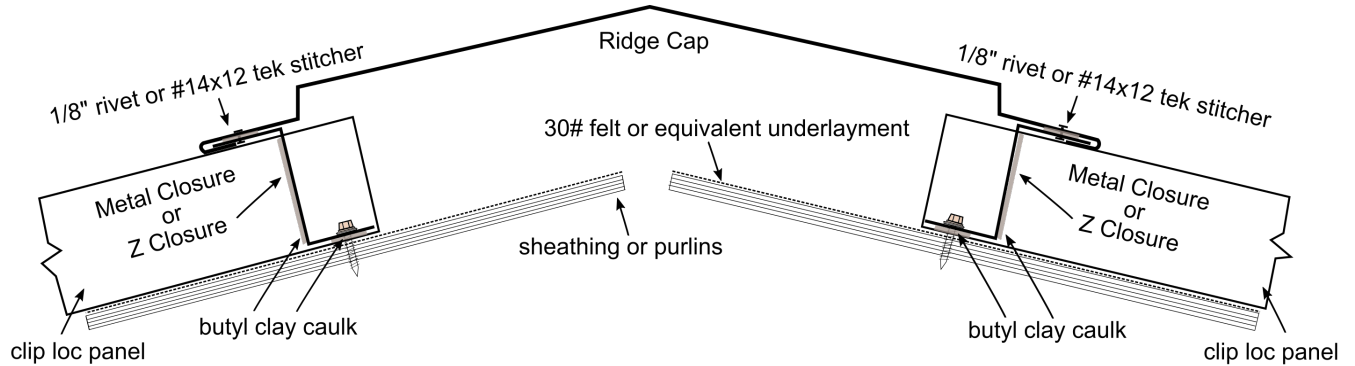

Notes:

1. Install roof panels.
2. Install metal closures, bedded in butyl clay, on three sides. Fasten with 4 screws per metal closure.
3. (Opt.) In place of metal closures, install z closure, notching to fit over panel rib.
4. Install ridge cap. Fasten ridge cap to top of metal closure with 1/8" rivets or #14x12 tek stitcher.

* Trim pieces must be ordered with "open hems" to be able to hook over closure flange. Otherwise fasten on top of closure.

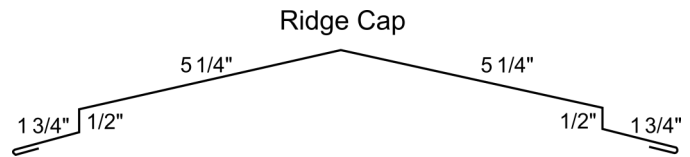

Z Closure

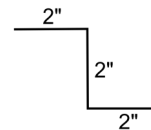

Metal Closure

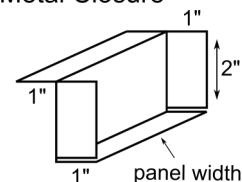

Vented Ridge Cap

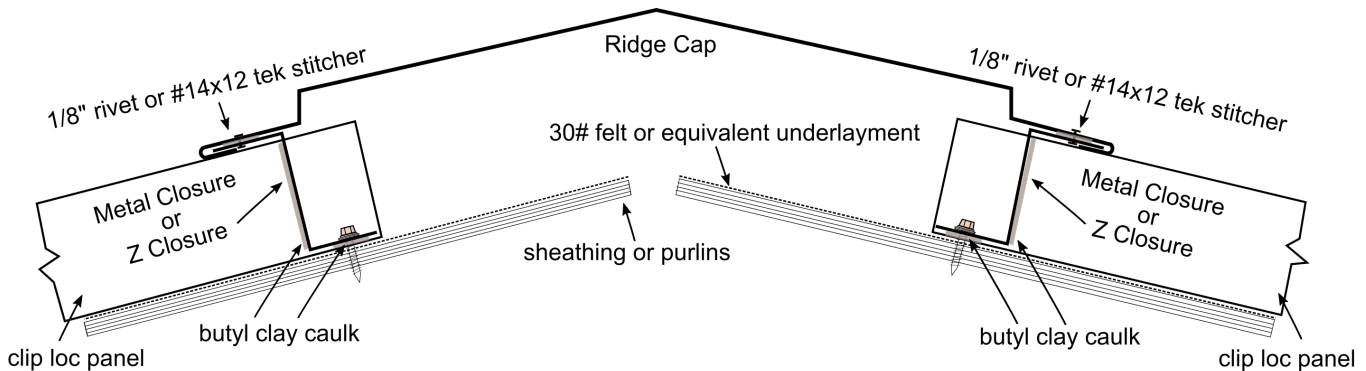

Notes:

1. Install roof panels.
2. Install Snap Z venting between ribs of panel, bedded in butyl clay on four surfaces- (*bottom*-between Snap Z and roof panel; *top*-between Snap Z and ridge cap; *ends*- between Snap Z and side of panel rib).
3. Screw inside flange of Snap Z through panel to sheathing or purlins.
4. Install ridge cap. Fasten ridge cap to Snap Z with rivets.

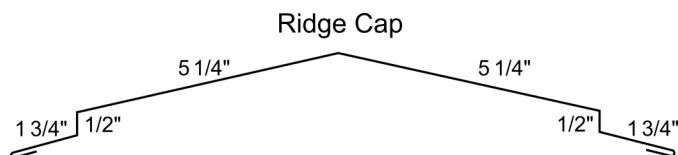

Snap Z Venting



Top Shed Flashing

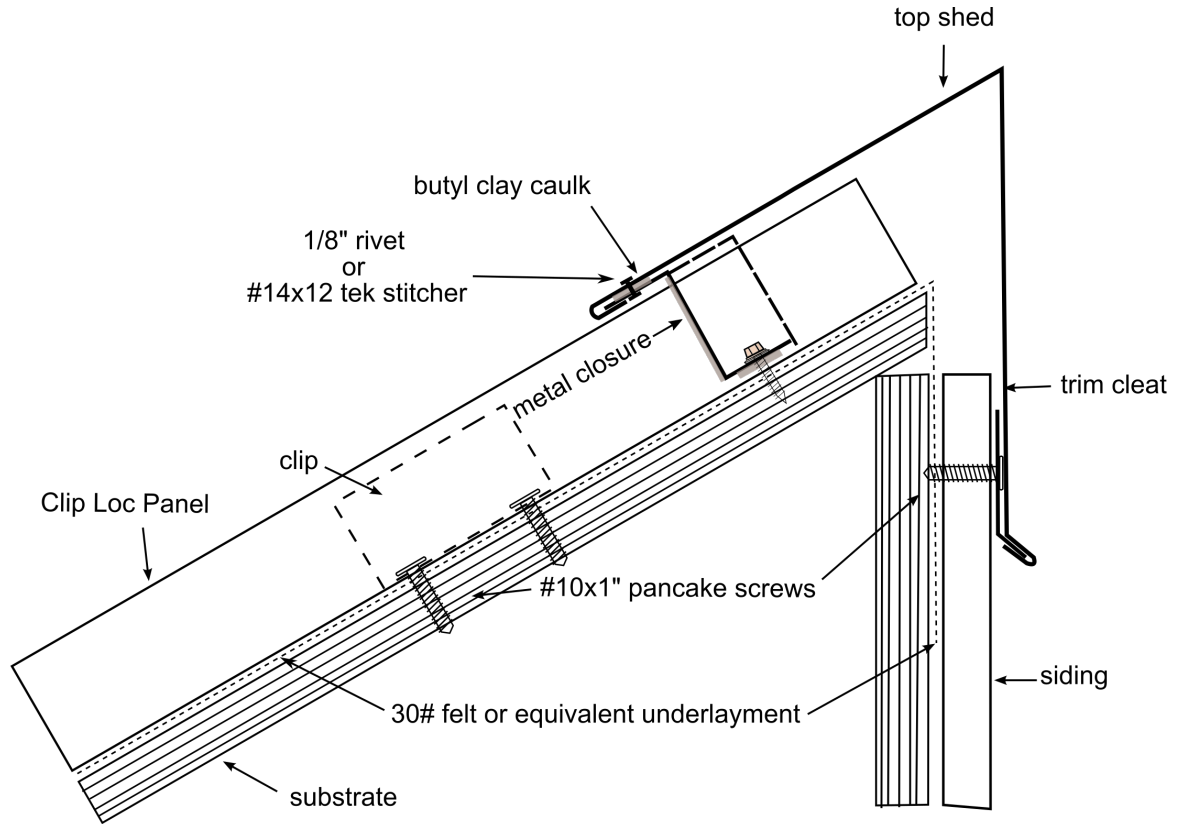

Notes:

1. Install roof panels
2. Install metal closures, bedded in butyl clay, on three sides. Fasten with 4 screws per metal closure.
3. Install trim cleat.
4. Install top shed flashing.
Fasten to metal closure
12"- 18" O.C.

* Trim pieces must be ordered with "open hems" to be able to hook over closure flange. Otherwise fasten on top of closure.

Trim Cleat

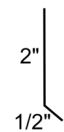

Closed Top Shed

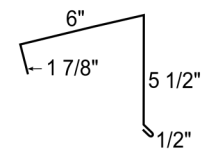

Metal Closure

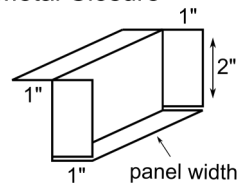

Top Shed

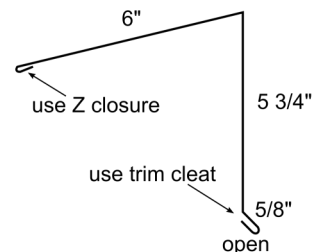

Vent Pipe Details

Aztec Standard Master Flash®

- Made of EPDM or Silicone, these flashings are compounded specifically for maximum resistance to weathering due to ozone and ultraviolet light.
- Fast, one piece construction allows for easy on-site installation in approximately 5 minutes.
- The soft aluminum base is designed to form a seal on most panel configurations and roof pitches regardless of pipe location.

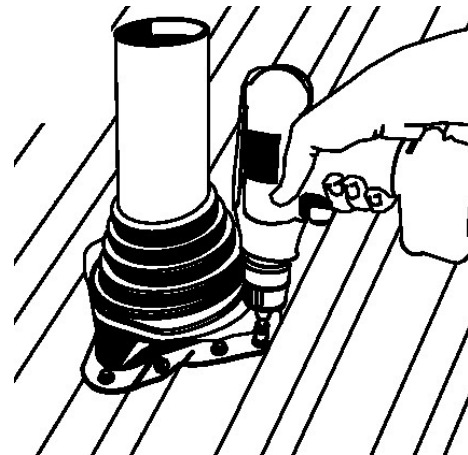

Installation:

1. Trim the pipe flashing to an opening 20% smaller than the pipe.
2. Wet the flashing with water and slide it over the pipe.
3. Press Master Flash down, bending it to conform to roof profile or roof irregularities. A blunt tool will help press flashing into tight roof angles.
4. Apply sealant under the flashing and fasten with roofing screws, spaced no more than 1 1/2" apart.

Note: If pipe has a seam, apply sealant where flashing crosses the seam. Apply sealant on upper edge of flashing wherever it is not tight to the roof.

Retrofit Master Flash®

- Retrofit Master Flash is designed to seal existing pipes/vents where a standard pull-over flashing cannot be assembled. The split design allows for an easy wrap around installation. Snap rivets and cable tie are included.



Note: If the pipe flashing crosses a panel rib, that underlap rib requires sealant 12-18" above the flashing before installing the next panel to prevent water infiltration.

Clip Loc End-Lap Detail

When you have a situation where the Clip Loc panels need to be end-lapped, we recommend becoming familiar with this installation procedure **BEFORE** ordering your material.

To end-lap Clip Loc, the following procedure **MUST** be followed:

- The lower panel needs to be cut as shown (1). The female rib is cut off approximately 4" to 6" down the panel or as required by the pitch of the roof (the flatter the roof the greater the overlap). The flat portion of the panel is left on so that it can be overlapped by the top panel (2). The male rib of the upper panel (2) needs to be cut back as shown to be able to slide inside the male rib of the lower panel.
- Install the lower panel as usual, then apply a bead of metal roof sealant on the flat portion of the lower panel where the upper panel will overlap.
- Next, apply the upper panel (2). The upper panel ribs should overlap the trimmed ribs of the lower panel (1) and butt up against the non-crimped ribs of the lower panel. Apply metal roof sealant or butyl tape to the joints.
- In the next run of panel, the same application procedure is used with one exception: **THE JOINTS MUST BE STAGGERED IN ORDER TO ENSURE A WEATHER-TIGHT SEAL (3)**. To stagger the joints in an orderly manner, the panels are normally ordered in two different lengths. If a 24'-0" run is used, an order could be made of one panel length of 14'-6" and the other at 10'-0" (allowing a 6" overlap). By doing this, the first run would be started with the longer panel on the bottom. In the next run, the shorter panel would be on the bottom, etc.

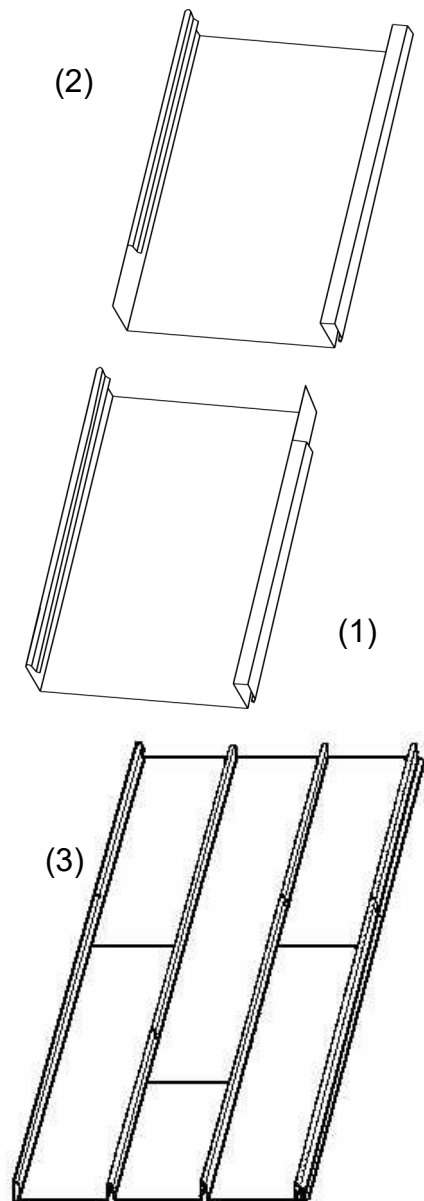

Parapet Cap

Notes:

1. Install roof panels.
2. Field bend last panel against parapet face.
3. Install custom parapet cap over parapet, overlapping field bent edge of roof panel.
4. Fasten through parapet cap and edge of roof panel.

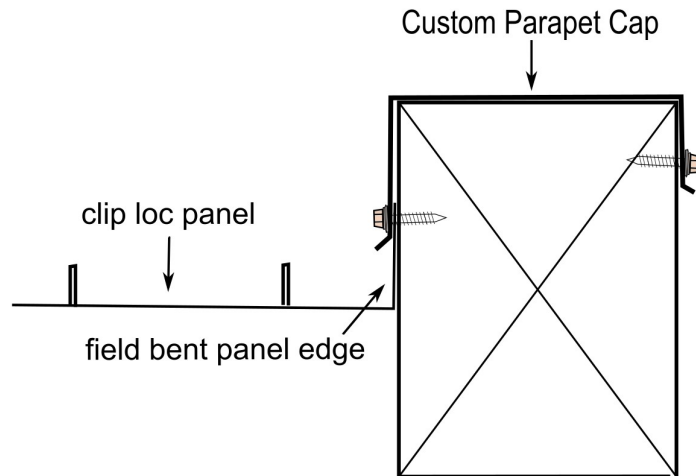
Notes:

1. Install roof panels.
2. Field bend last panel against parapet.
3. Install sidewall trim over field bent edge of roof panel.
4. Install flat of sheet metal on parapet face, overlapping sidewall trim. Fasten through flat and sidewall trim.
5. Install custom parapet cap.
6. Fasten through parapet cap and flat.

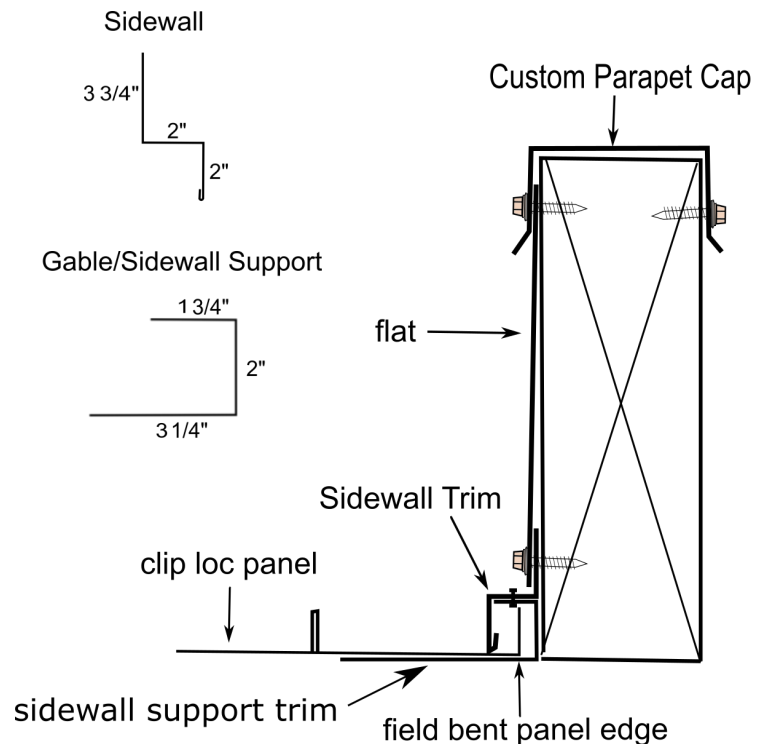

Cricket Application

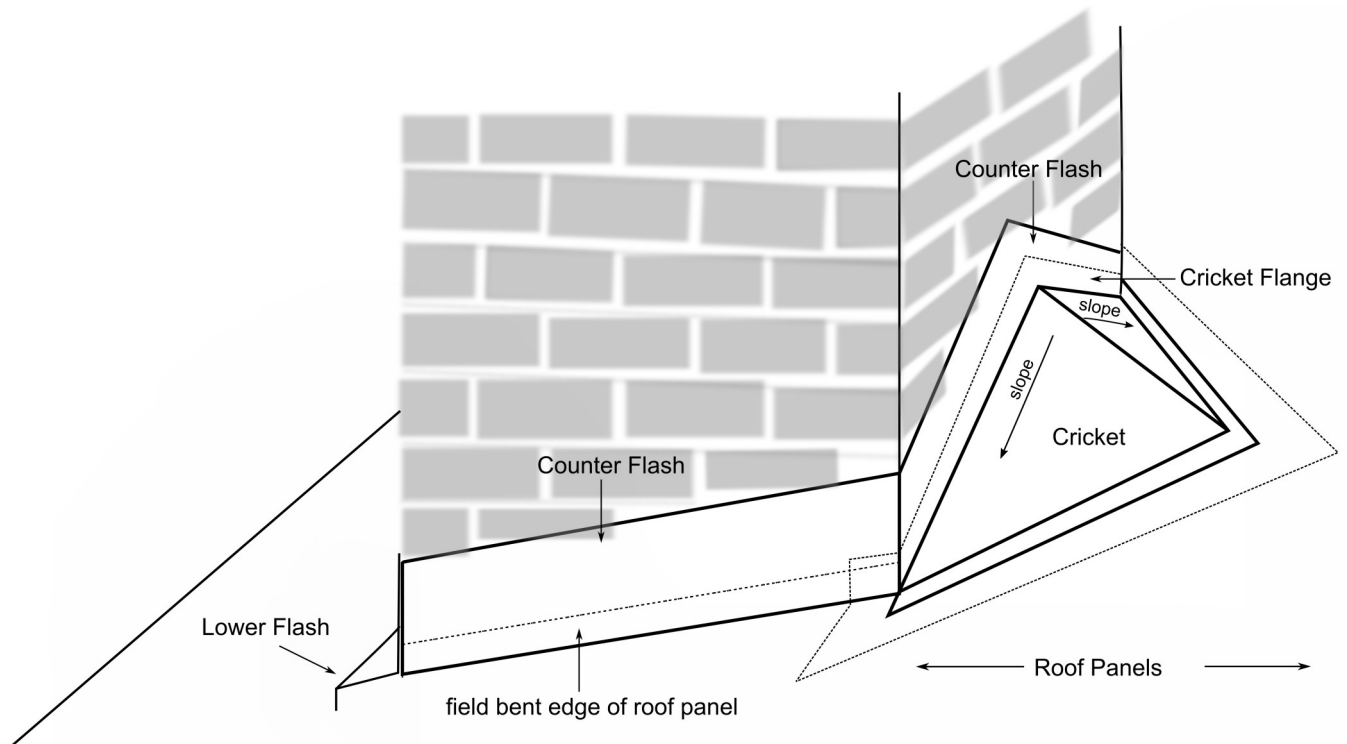

Notes:

1. Frame a cricket on upper side of chimney. Sheet with plywood.
2. Field fabricate flat sheet to fit plywood cricket.
3. Install roof panels. Field bend edge of roof panel against chimney side.
4. Install counter flashing above cricket, overlapping cricket flange. (*See additional details in box below.*)
5. Install counter flashing on chimney sides, overlapping field bent edge of roof panel.
6. Install lower flash on lower side of chimney, overlapping roof panels.

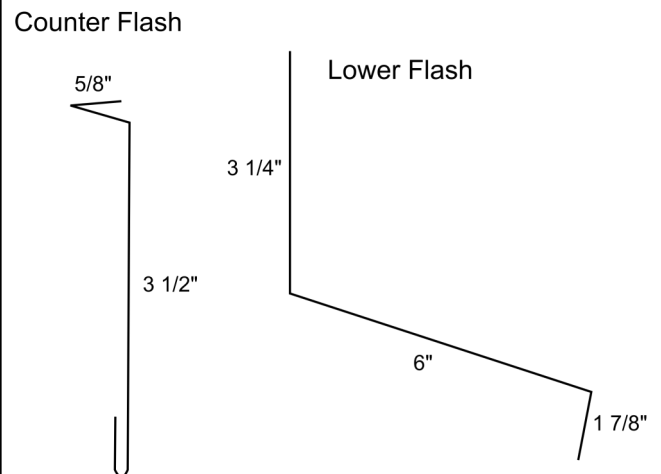

Counter flashing is used around a brick or masonry chimney.

- Using a masonry blade in a circular saw, cut a 1/2"-1" deep groove around the chimney at the correct height from the roof deck.
- Blow any dust out of the groove and insert the "V" part of the flashing into the groove along with metal roof sealant.
- Fasten the flashing to the chimney with a compatible masonry anchor.

Skylight Flashing

The following steps illustrate one way to flash a skylight or a chimney.
Jobsite conditions may require alternate dimensions or installation techniques.

Use metal roof sealant at all joints and where metal is to be overlapped.

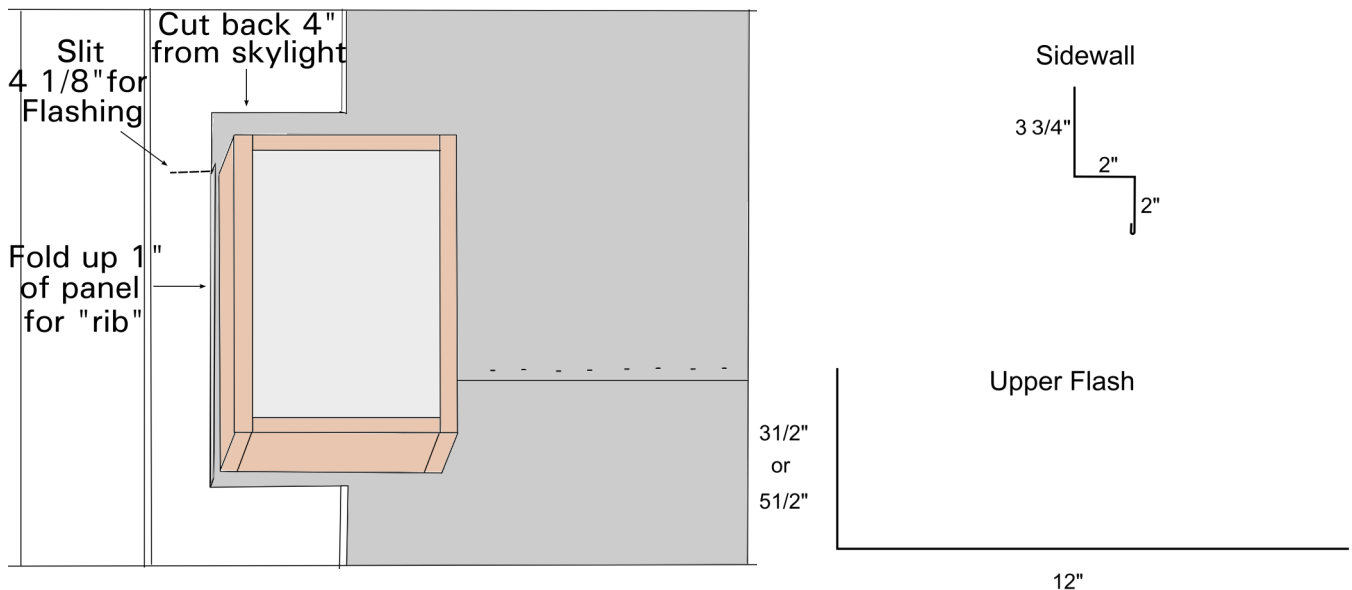

Step # 1

- Install panels around skylight.
- Above skylight, cut the roof panel back 4" (so ribs do not interfere with drainage).
- Where the panel is notched to the side of the skylight, leave 1" of panel to bend up, creating a false rib (to be covered later with sidewall flashing).

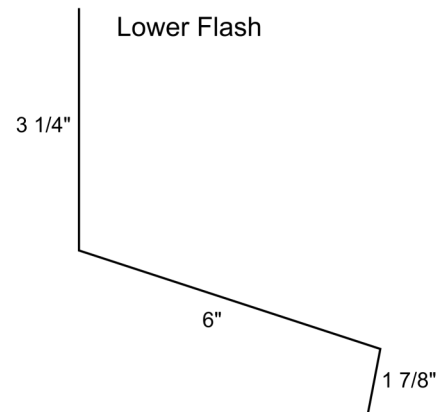

Skylight Flashing (cont.)

Step # 2

- Install Upper Flashing above skylight, leaving a minimum 4" flange (on each side) wider than the skylight.
- Install panels above skylight, allowing 4"-6" of space to the skylight.
- Apply sealant between the upper panels and the upper flashing.

Optional:

Fasten offset cleat, bedded in butyl clay, on top of upper flash with #10x1" pancake screws. Install roof panels. Bend end of panel around offset cleat

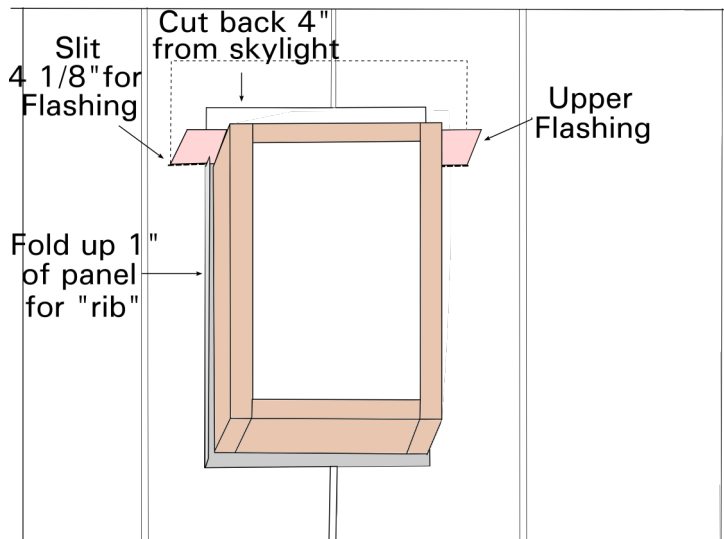

Step # 3

- Install Lower Flashing at the downhill side of the skylight.
- Cut the flashing to the width of the skylight plus 2" on each side.
- Cut back along the bend 2" on each side.
- Bend the metal around the curb as detailed to the right.
- Install Sidewall Flashing by cutting the top leg a minimum of 2" long.
- Fold around the front of the curb.
- Do this for both sides of the skylight.

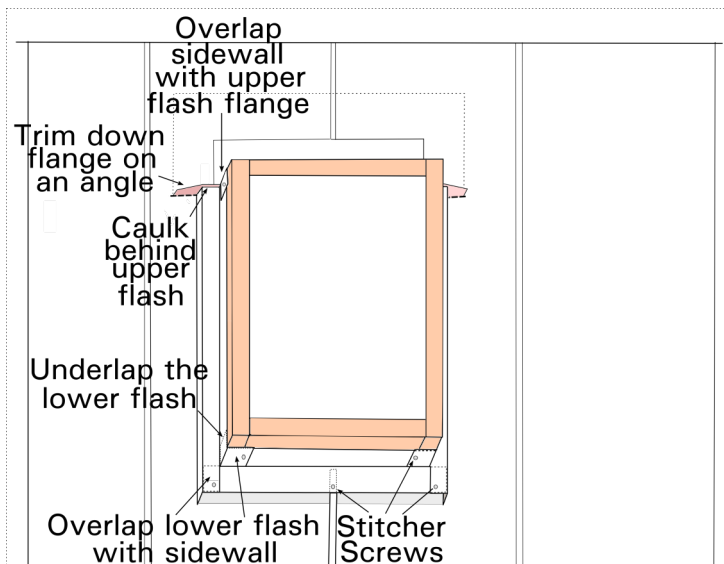

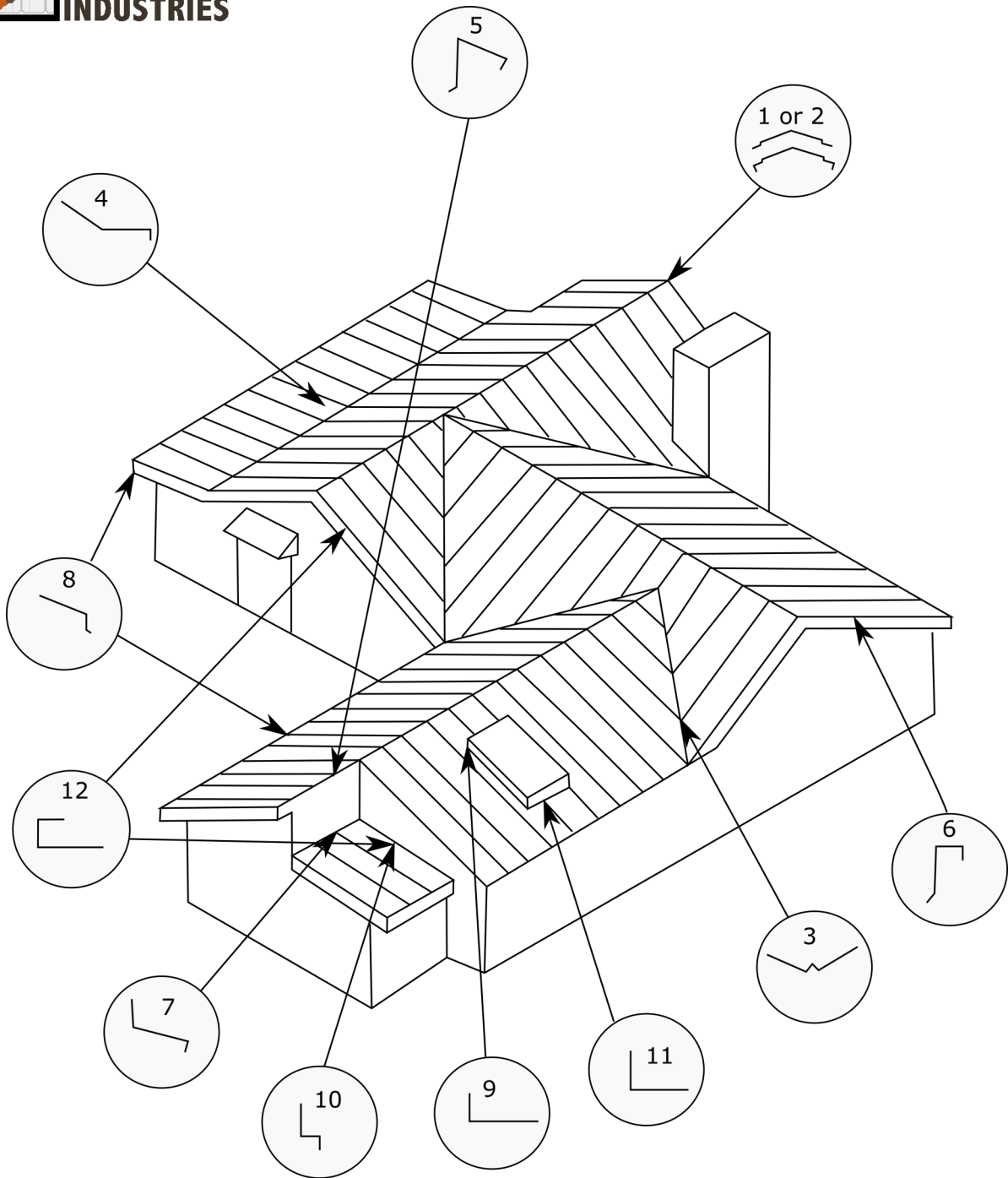

- | | |
|--------------------------------|------------------------------|
| 1. Ridge Cap - Vented * | 7. Endwall Flashing –Closed* |
| 2. Ridge Cap - Closed * | 8. Eave Trim * |
| 3. W Valley * | 9. Upper Flashing * |
| 4. Pitch Change - Closed ** | 10. Loc Seam Sidewall |
| 5. Top Shed Flashing –Closed * | 11. Lower Flashing * |
| 6. Gable Trim | 12. Gable/Sidewall Support |

Numbers pertain to this drawing only. When ordering, use item name.

* Pitch needed

** Two pitches needed

CLIPLOC Roof Panel

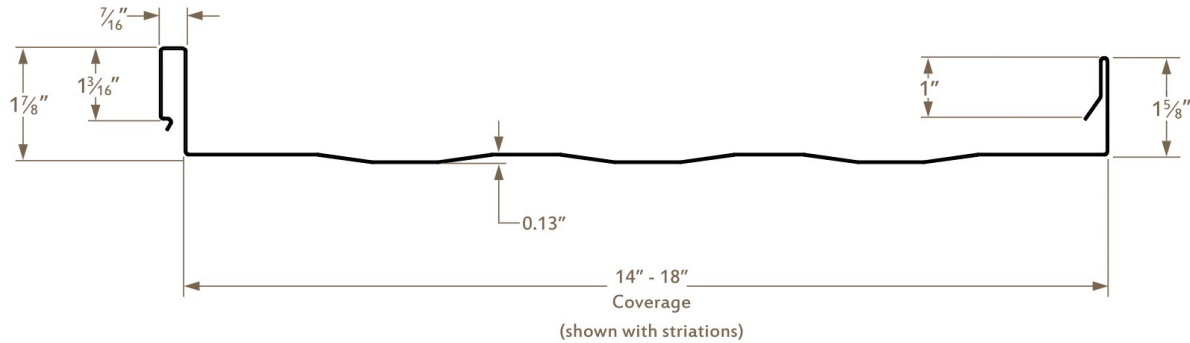

**AGRICULTURAL/
COMMERCIAL**

**CONCEALED
FASTENERS**

17 5/8" COVERAGE

**MINIMUM SLOPE
2:12**

**OPEN FRAMING/
SOLID SUBSTRATE**

PANEL DESCRIPTION

- Applications: Commercial, Industrial, Agricultural, and Residential
- Limited 40-year warrantied paint
- Finishes on 24 ga: 10 standard PVDF colors
- Corrosion Protection on Substrate:
 - AZ-50 (ASTM A792) for painted Galvalume®
 - G-60 (ASTM A653) for painted Galvanized
 - G-90 (ASTM A653) for PVDF painted 24 gauge
- DuPont™ Teflon® surface protector on all standard colors
- Sheet lengths: One inch increments to any length
- Optional: 26 or 22 gauge steel, custom colors, and pre-painted aluminum
- Installation utilizes a clip that allow for expansion and contraction
- For color availability, cool roof specs, and other panel info, please see our website: www.metallionindustries.com

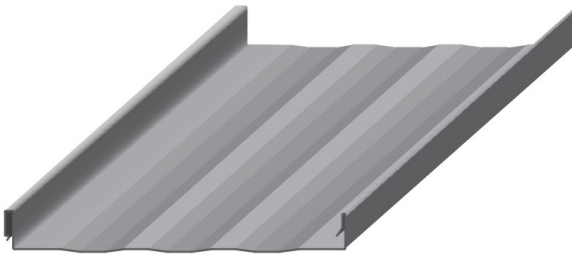

TESTING DATA



- UL 2218 Impact Resistance
- UL 790, 263 Fire Resistance
- UL 580 Uplift Resistance

OFFICE (503)630-7740 FAX (503)630-7770 www.metallionindustries.com
850 NW Park Ave. Estacada, OR 97023 Open Weekdays 8:00-5:30 PST

CLIPLOC Roof Panel

PANEL FASTENING

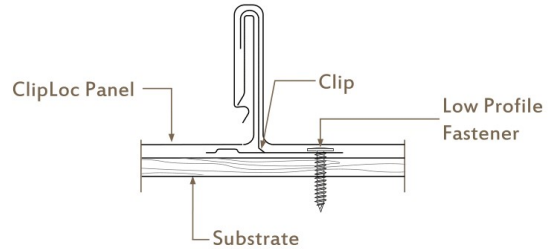

CLIP & FASTENER INFORMATION

Fasten Clip to Wood using:

#10-9 Low Profile Wood Screw

Fasten Clip to Steel using:

#12-14 Low Profile Drill-Tip Screw

Types of clips vary according to installation and application needs. Clips accommodate thermal expansion and contraction.

Screw thread should protrude no less than 1/4" through the substrate.

UL PANEL CLIP

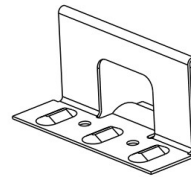

Utilizes Two Fasteners

Clip Loc Allowable Loads (lbs/ft ²) per span			Wind Load Factor = 1.0 (not increased 33%)										
Ga	Span	Load Type	2'	2.5'	3'	3.5'	4'	4.5'	5'	5.5'	6'	6.5'	7'
24	Single	L/180	205	131	90	66	50	39	32	26	22	18	16
		L/240	205	131	90	66	50	39	32	26	22	18	16
		L/360	205	131	90	66	50	39	30	23	18	14	11
	Double	L/180	205	131	90	66	50	39	32	26	22	18	16
		L/240	205	131	90	66	50	39	32	26	22	18	16
		L/360	205	131	90	66	50	39	32	26	22	18	16
	Triple	L/180	231	149	104	76	58	46	37	30	25	21	18
		L/240	231	149	104	76	58	46	37	30	25	21	18
		L/360	231	149	104	76	58	46	37	30	25	21	18

24 gauge has .0236" min Substrate Thickness, 50 KSI Tensile (UL)

Panel Width: 18", ASTM A653

Loads are averages from similar products with design loads meeting AISI specifications

Oil Canning: Flat metal surfaces can display waviness, commonly referred to as "oil canning", which is an inherent characteristic of steel. "Oil canning" is not a defect and therefore not an acceptable reason for rejection.

OFFICE (503)630-7740 FAX (503)630-7770 www.metallionindustries.com
850 NW Park Ave. Estacada, OR 97023 Open Weekdays 8:00-5:30 PST



www.metallionindustries.com

Hours: Mon.—Fri. 8—5:30

850 NW Park Avenue

Estacada, OR

Fax 503-630-7770

503-630-7740

“Live Every Day For Jesus!”