

# METALLION INDUSTRIES

RESIDENTIAL • COMMERCIAL • AGRICULTURAL

## PRODUCT CATALOG



ROOFING • SIDING • ACCESSORIES

<b>ROOF &amp; WALL CLADDING</b>	Panel Guide	1
	Exposed Fastener Panels	2-5
	Concealed Fastener Panels	6-8
	Mechanically Seamed Panels	9
	Metal Shingles	10-11
<b>TRIM</b>	Steel Siding	12
	Standard Trim & Flashing	13
	PBR Trim & Flashing	14
	Loc-Seam Trim / Chimney & Skylight Flashing	15
	Soffit & Fascia Trim	16
	MI-150 Trim	17
	MI-200 / MI-210 Trim	18
	Clip-Loc Trim	19
<b>DOORS</b>	Steel Siding Trim	20
	Entry Doors	21-22
	Arcadian Dutch Doors	22
	Sliding Door Hardware	23
<b>FASTENERS</b>	Overhead Doors	24-25
	Wood Fasteners	26
	Self-Drilling Fasteners & Rivets	27-29
<b>INSULATION &amp; UNDERLAYMENT</b>	Concrete Anchors / Frame Bolt Assemblies	30
	Underlayment	31
<b>SEALANTS &amp; CLOSURE</b>	Insulation / Vapor Barrier	32
	Adhesives & Sealants	33-34
	Pipe Flashings	35-36
<b>TOOLS</b>	Venting & Closure Foam	36-37
	Cutting, Folding & Crimping Tools	38-41
	Caulk Guns	41
	Saw Blades	42
	Drill Bits	43-44
	Measuring Tools & Safety	44-45
<b>BUILDING ACCESSORIES &amp; LIGHT PANELS</b>	Miscellaneous Items & Rental Equipment	45-46
	Polycarbonate Panels / Fiberglass Panels	47
	Cupolas / Weathervanes	48
	Horse Stall Components	49

**METALLION INDUSTRIES PANEL PRODUCTS**

	GAUGE	COVERAGE	APPLICATION	COLORS
<b>Traditional Metal Roof &amp; Wall Panels (Exposed Fasteners)</b>				
MAGNA-RIB	29 / 26*	36"	ROOF & WALL	PAINTED & GALV
PBR	26 / 24*	36"	ROOF & WALL	PAINTED & GALV
DELTA-RIB	29	24"	ROOF & WALL	PAINTED & GALV
CORRUGATED	29	24" (21" roof)	ROOF & WALL	PAINTED & GALV
<b>Residential &amp; Commercial Roof Panels (Concealed Fasteners)**</b>				
LOC-SEAM	26 / 24*	12" / 16"	ROOF	PAINTED
CLIP-LOC	26* / 24	17 <sup>5</sup> / <sub>8</sub> " (13 <sup>3</sup> / <sub>4</sub> " 26ga.)	ROOF	PAINTED
MECHANICAL SEAM	24	16" / 18"	ROOF	PAINTED
<b>Seamless Metal Soffit &amp; Siding Panels (Concealed Fasteners)**</b>				
FLUSH PANEL	24	12"	SOFFIT & WALL	PAINTED
BOARD & BATT	26 / 24*	11 <sup>3</sup> / <sub>4</sub> "	WALL	PAINTED
STANDARD LAP	26 / 24*	11 <sup>3</sup> / <sub>4</sub> "	WALL	PAINTED
DUTCH LAP	26 / 24*	11 <sup>3</sup> / <sub>4</sub> "	WALL	PAINTED

\* Non-Standard Gauge – See Sales Agent for Details

\*\* Full Length Panels can be Manufactured at your Jobsite - See Sales Agent for Details and Limitations

Our flagship product line: Metallion Industries' roll-formed steel roofing and siding panels are engineered and manufactured to provide your structure with superior protection against the elements, resulting in long-lasting beauty and performance.

All of our premium panel lines utilize only high-quality steel and coatings, with each panel visually inspected at the time of manufacturing to ensure that you receive only the best. See our website below for our paint warranty information and more.

Please contact our friendly and knowledgeable staff today to discuss how we can enhance your next building project!

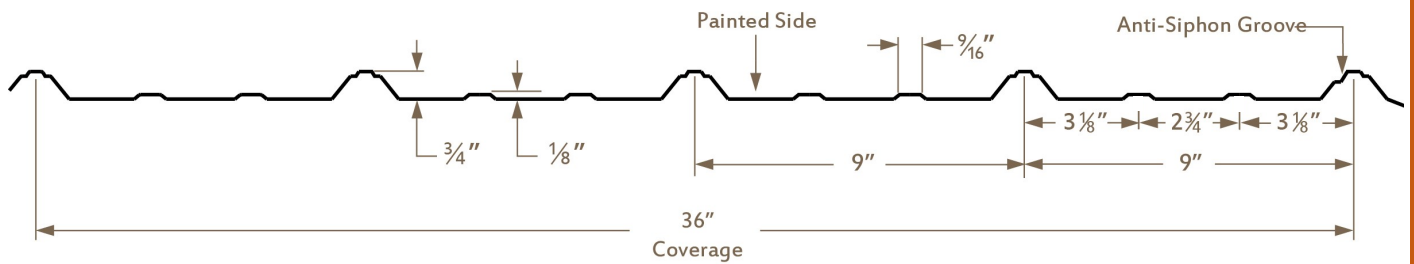
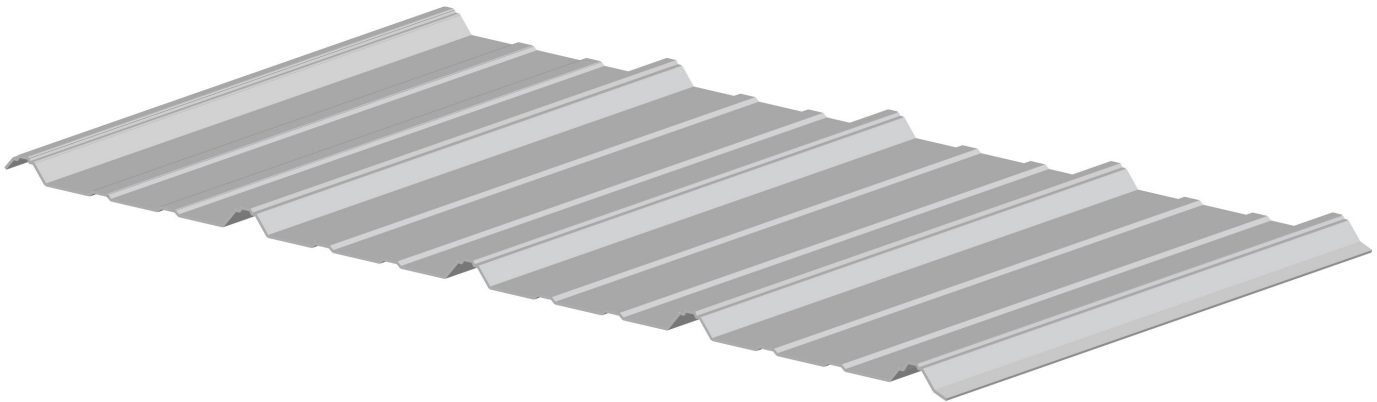

## MAGNA RIB

Magna Rib is our most popular panel due to its versatility, economic value, and unique design. Reinforced major ribs not only strengthen the panel but improve panel alignment during installation. This 36" panel is most often used on pole barns, sheds, and other light industrial buildings.

### AT A GLANCE

- Full 36" net coverage
- Purlin-bearing edge for strength and speed while fastening side laps
- Anti-siphoning side lap
- 8 intermediate stiffening ribs add extra strength to this panel
- Custom lengths 1' through 50' in cut-to-length one inch increments
- For color availability, additional specifications, and other information, please contact us or visit our website: [www.metallionindustries.com](http://www.metallionindustries.com)



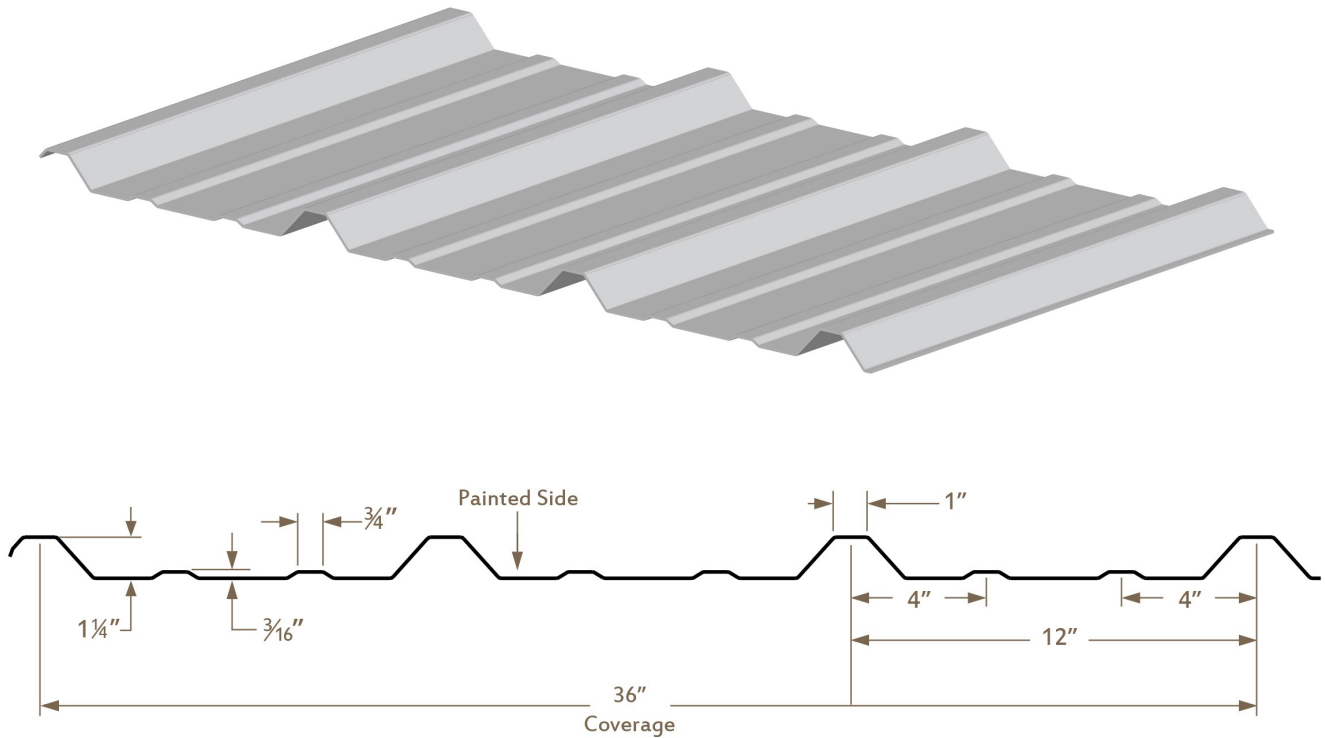

## PBR

The PBR profile excels in commercial and industrial applications. Our PBR is made with heavy gauge steel – allowing panels to span up to five feet on purlins. The tall ribs not only increase load bearing capabilities, but deter water from siphoning under the overlap rib, making PBR ideal for low-sloped commercial roofs.

### AT A GLANCE

- Full 36" net coverage
- Excellent for commercial and industrial applications
- 26 gauge full hard (80 ksi) steel
- PBR panels require a minimum slope of 1/2:12
- UL90 rating when attached to steel purlins
- Custom lengths 1' through 50' in cut-to-length one inch increments
- For color availability, additional specifications, and other information, please contact us or visit our website: [www.metallionindustries.com](http://www.metallionindustries.com)





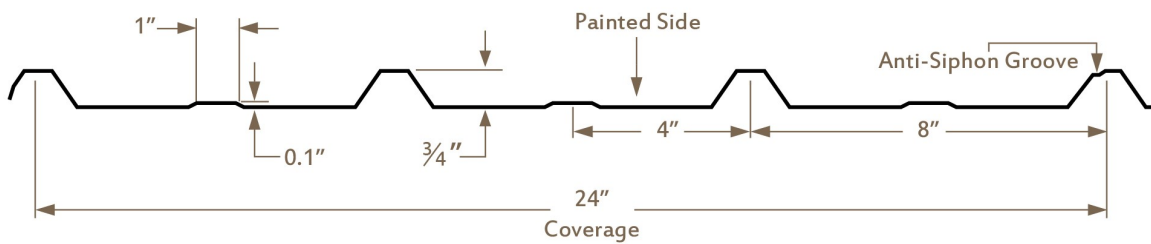
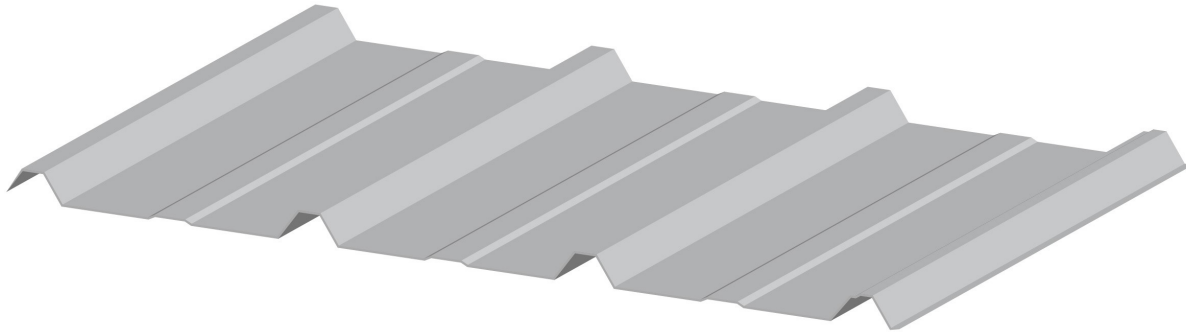

## DELTA RIB

Delta Rib is an exposed fastener panel that is designed to carry heavier loads; perfect for the job that requires more strength. These narrow panels are more accommodating for steep-sloped roof installations or one man crews.

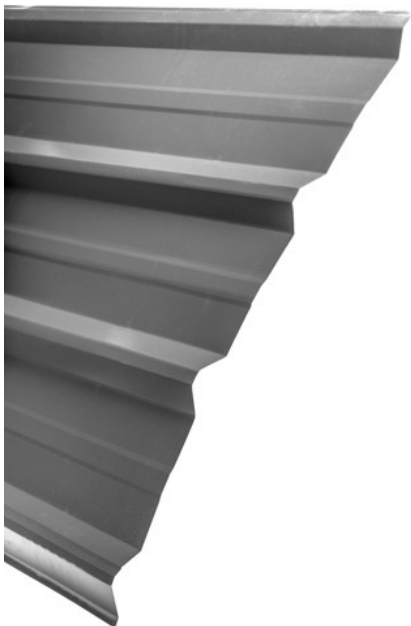

### AT A GLANCE

- Full 24" net coverage
- Through fastened panel for roofing or siding
- Purlin-bearing edge for strength and speed while fastening side laps
- Anti-siphoning side lap
- Custom lengths 1' through 50' in cut-to-length one-inch increments
- For color availability, additional specifications, and other information, please contact us or visit our website: [www.metallionindustries.com](http://www.metallionindustries.com)

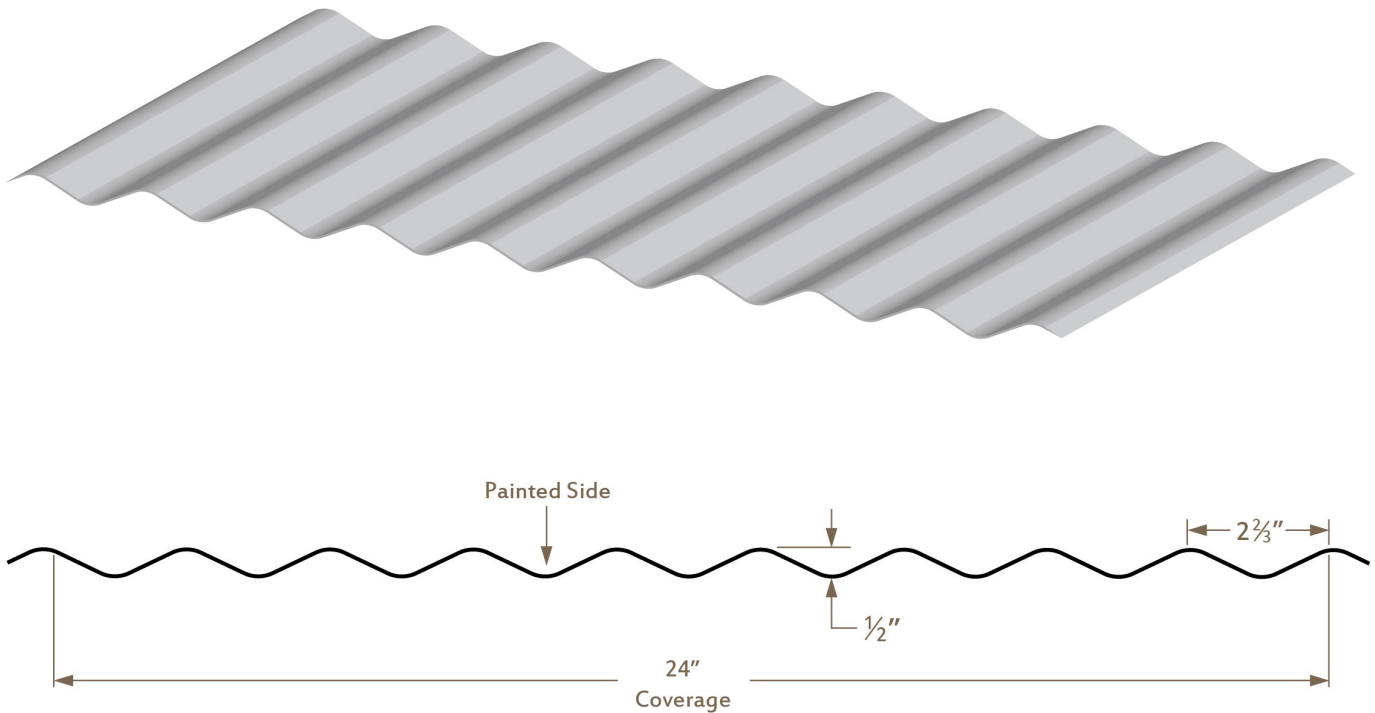

## CORRUGATED

The history of corrugated metal panels reaches back almost 200 years ago and, having survived the test of time, they still are in demand today – especially for those wanting to maintain a rustic, traditional appearance. Our 2 ½" Corrugated panels are only 26" wide, making them more accommodating for one-man crews.

### AT A GLANCE

- Full 24" net coverage for siding applications
- 21" net coverage for roofs
- Through fastened panel for roofing or siding
- Custom lengths 2' through 50' in one inch increments
- Traditional style looks great in agricultural, light industrial or residential applications
- For color availability, additional specifications, and other information, please contact us or visit our website: [www.metallionindustries.com](http://www.metallionindustries.com)



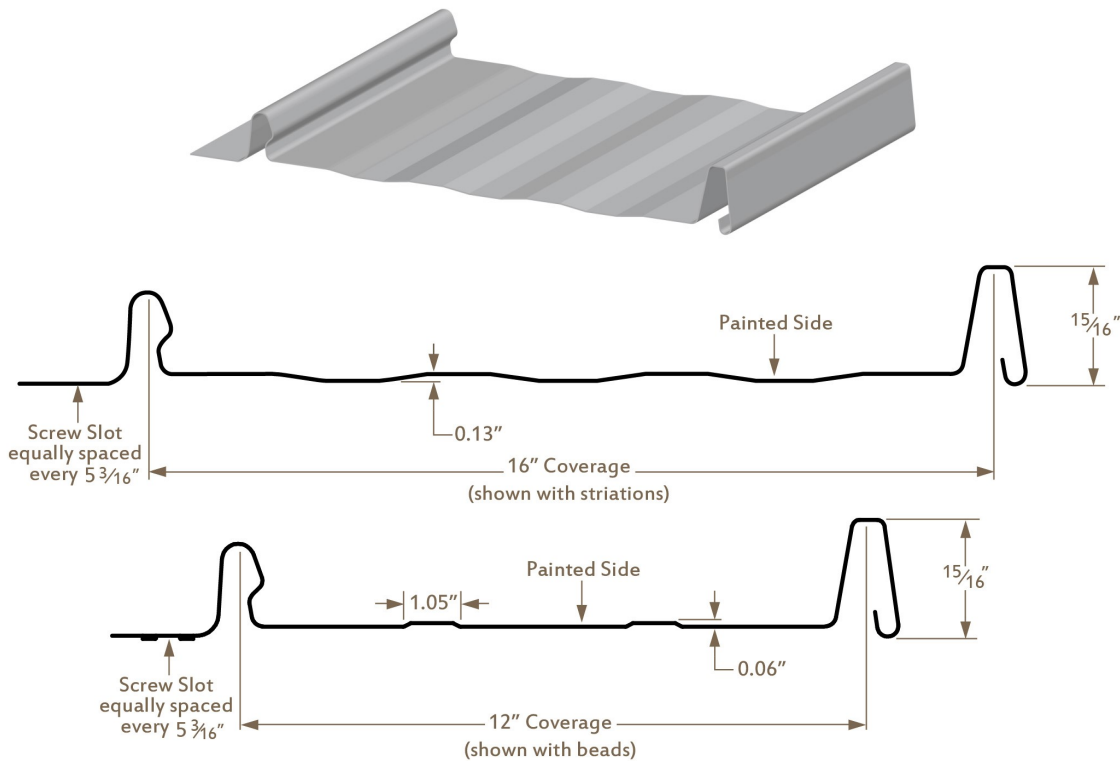

## LOC SEAM

Loc Seam is especially popular with insulated buildings because concealing the fasteners greatly reduces the chance that a failed washer will result in an expensive leak. A “concealed fastener” panel not only reduces maintenance concerns by protecting fasteners from the elements, but the smooth design allows debris from trees to wash or blow off the roof easier – reducing frequency of roof cleanings.

### AT A GLANCE

- Full 12" or 16" net coverage
- Low maintenance and easy installation
- Residential / Commercial applications
- No exposed fasteners
- Installed over solid substrates with underlayment
- On-site roll forming to custom lengths available
- Direct fastened—no clips necessary
- Teflon® “non-stick” additive in our standard paint
- For color availability, additional specs, or other information, please contact us or visit our website





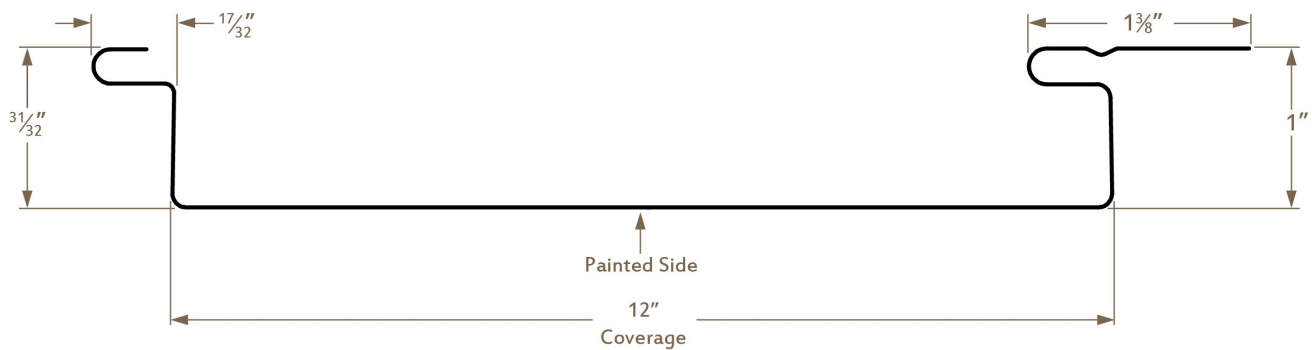
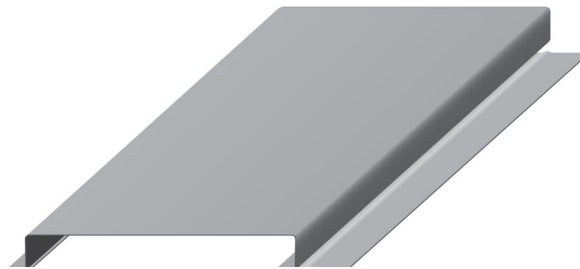

## FLUSH PANEL

Flush Panel is a concealed fastener system for creating sleek, smooth walls, vented soffits, or simple and attractive fascia coverings. Our Flush Panel gives you an aesthetic option. Typically made using 24 gauge steel — you may rest assured that your Flush Panel application has the utmost durability.

### AT A GLANCE

- Full 12" net coverage
- Attractive choice for wall, fascia, & soffit applications
- Can be installed vertically or horizontally
- Concealed fastening system
- Perforations available for vented soffit applications
- On-site roll forming to custom lengths available
- Adjustable reveal: from 0" to 3" in 1/2" increments
- Standard flat pan; available with beads or striations
- For color availability, additional specs, or other information, please contact us or visit our website



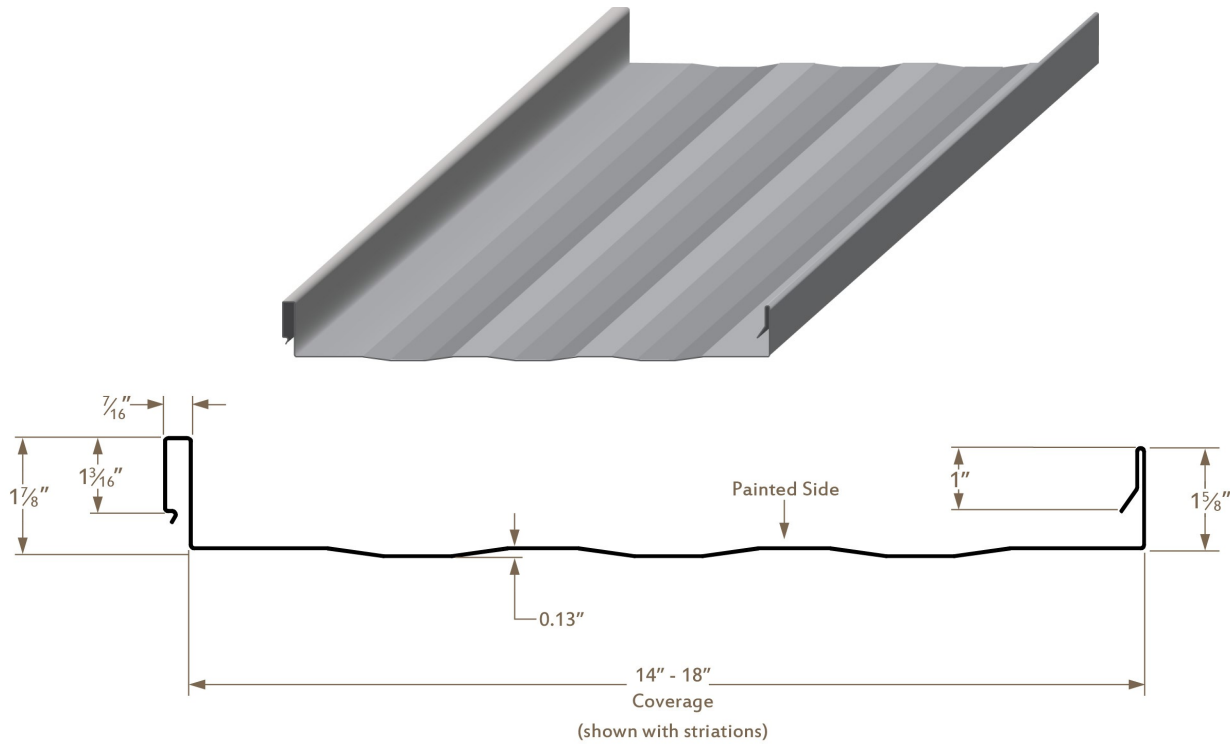

## CLIP LOC

Clip Loc panel is a snap-together panel (no seaming required) designed for commercial, light structural or residential applications. The traditional flat-pan look is not only aesthetically pleasing but engineered to exceed most wind load requirements in the country.

### AT A GLANCE

- 17 5/8" net coverages available (13 3/4" in 26 gauge)
- 24 gauge pre-painted G-90 standard (22 gauge optional)
- Bold 1 7/8" tall seam
- On-site roll forming to custom lengths available
- Special clip allows for full 2" of thermal movement
- Optional factory or field-applied side lap sealant
- Weathertight warranty option
- Can be applied over solid substrates, steel decking with polyiso, or in limited applications over open purlins
- For color/custom coil availability, additional specs, or other information, please contact us or visit our website



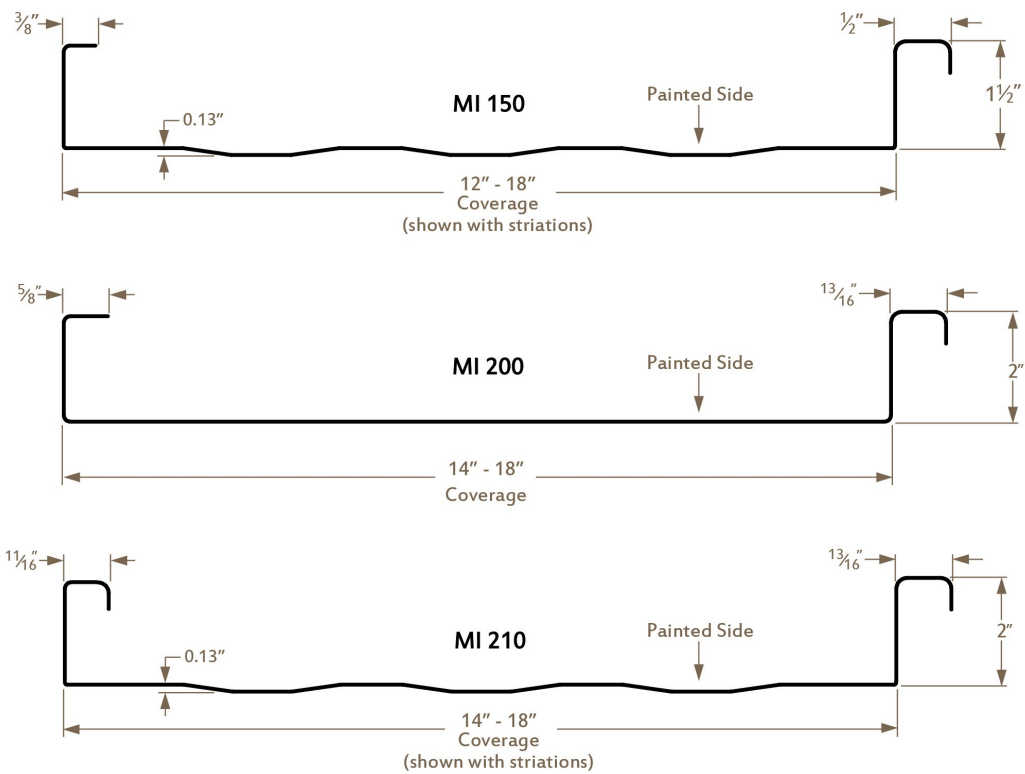

## MECHANICAL SEAM

Our mechanically seamed panels, designed for architectural and commercial applications, are available in different configurations to accommodate a large variety of situations. The traditional flat-pan look is not only aesthetically pleasing but engineered to exceed most wind load requirements in the country.

### AT A GLANCE

- 16" or 18" net coverages standard
- 24 gauge pre-painted G-90 standard (22 gauge optional)
- On-site roll forming to custom lengths available
- Clip system allows for thermal expansion & contraction
- Single and Double seaming machines available for rent
- Optional factory or field-applied side lap sealant
- Weathertight warranty option
- Can be applied over solid substrates, steel decking with polyiso, or in limited applications over open purlins
- For color/custom coil availability, additional specs, or other information, please contact us or visit our website

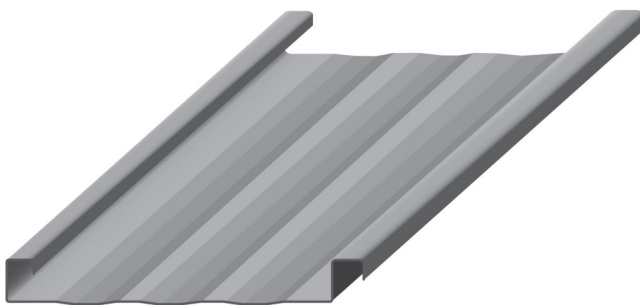

- Stone coated steel shingle ("XD" gives heavy cut look)
- Non-combustible class A rated material
- Low maintenance—can be safely walked on
- Interlocking panels provide weathertight barrier
- Transferable 50 year limited warranty
- Please contact us for available options, accessories, and pricing



Description	Width	Length
Shingle	21"	52"
Shingle XD	14 1/8"	52 3/8"
Shake	14 5/8"	53"
Tile	16 1/2"	52"

## DECRA

- The beauty of tile without the weight
- Made of 26 gauge commercial steel
- Excellent energy saving and disaster performance
- Specifically designed to seal out wind and weather
- Comes with a 20 year warranty
- Please contact us for available options, accessories, and pricing



Description	Width	Length
Met-Tile	38 5/16"	2' - 20' (in 1' increments)

## MET-TILE

- Galvanized steel substrate (28 or 30 gauge)
- Fluoropolymer PVDF finish (Kynar 500)
- Double embossed texture for extra strength
- Available in 22 designer colors
- Concealed fastening systems
- Unique embossed roll formed accessory package
- Limited lifetime warranty program
- Wind and fire ratings
- Please contact us for available options, accessories, and pricing

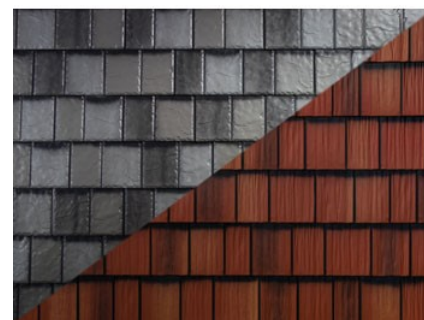

Description	Width	Length
Shingle Shake (30 ga.)	12"	50"
Shingle Shake (Enhanced)	12"	50"
Slate (28 ga.)	12"	50"
Slate (Enhanced)	12"	50"

## ARROWLINE

**Shingle Shake Panel**

50" x 12" - 12 pcs / ctn  
50 sq ft coverage



**Shingle Shake Ridge / Hip Cap**

20 pcs / ctn

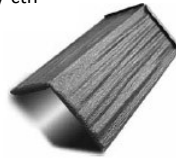

**Slate Panel**

50" x 12" - 12 pcs / ctn  
50 sq ft coverage

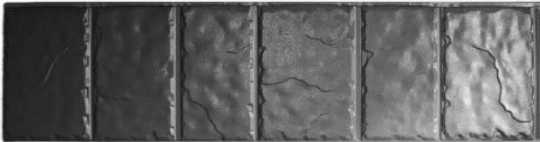

**Slate Ridge / Hip Cap**

20 pcs / ctn

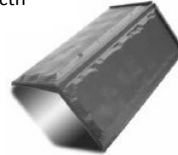

## ARROWLINE ACCESSORIES

**Eave Starter**  
10' Long



**3/8" J Trim**  
10' Long



**Open Valley Flashing**  
10' Long



**Valley Flashing**  
10' Long



**Valley Cap**  
10' Long



**End Wall Flashing**  
10' Long



**Rake Starter**  
10' Long



**Shingle / Valley Clip**  
750 / ctn .020" G90

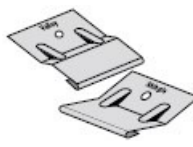

**Trimline Vent**  
10' Long

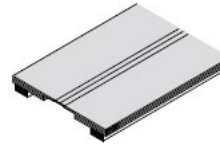

**Starter Base**  
10' Long

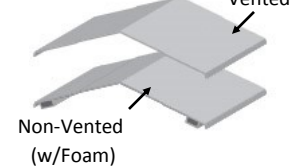

Available Colors		
Shingle Shake	Bright Red	Hartford Green
	Cedar	Pewter
	Charcoal Gray	Royal Brown
	Classic Blue	Sandstone
	Classic Red	Spruce Green
	Copper	Statuary Bronze
	Desert Tone	T-Tone
	Glacier White	
	Shingle Shake	Charcoal Blend
Hartford Green Blend		T-Tone Blend
Slate	Charcoal Gray	Hartford Green
	Classic Red	Stone
Slate	Charcoal Gray Blend	Stone Blend
	Classic Red Blend	

Description	PCS/CTN	Quantity
Shingle Shake / Slate	12	50 sqft / ctn
Eave Starter	10	100 lf
Rake Starter	10	100 lf
3/8" J Trim	10	100 lf
End Wall Flashing	5	50 lf
Valley Flashing	5	50 lf
Valley Cap	5	50 lf
Trimline Vent	5	50 lf
Starter Base	5	50 lf
Starter Base w/Foam	5	50 lf
12" Ridge / Hip Cap	20	20 lf
Shingle Shake Clip	100	120 / square
Valley Clip	100	2 / lf of valley
<i>All Accessories Are Velvet Embossed</i>		



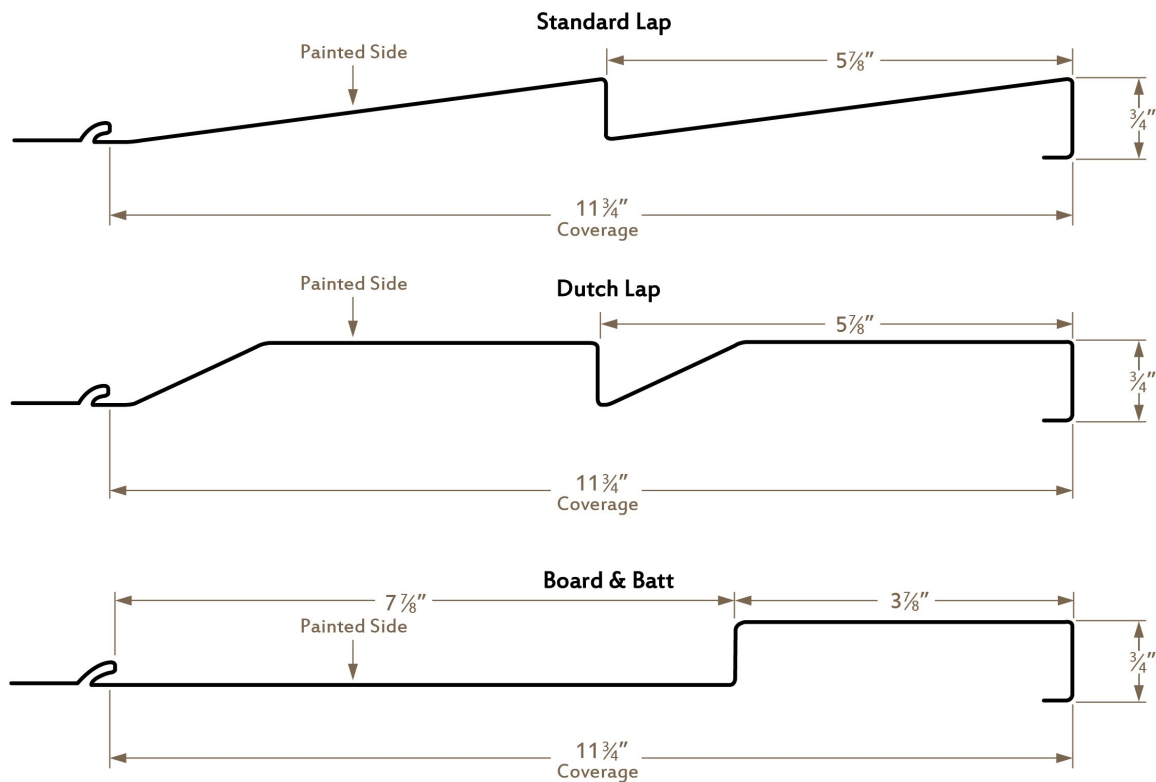

## SEAMLESS SIDING

Designed with minimal maintenance and longevity in mind, our durable 26-gauge steel siding is a sound investment. Our siding conceals the fasteners, creating a sleek, clean appearance. No unsightly caulking, lapping, or painting patchwork required. On site roll-forming makes long, seamless panels a reality!

### AT A GLANCE

- 11  $\frac{3}{4}$ " net coverage
- 26ga steel is more durable than wood or vinyl
- Concealed fastener system (no screws showing)
- Embossing (wood pattern) available
- Will not crack in cold temperatures
- Seamless (no end-lap joints)
- Baked-on, long-life finishes and low maintenance ensures life-cycle cost savings over conventional siding materials.

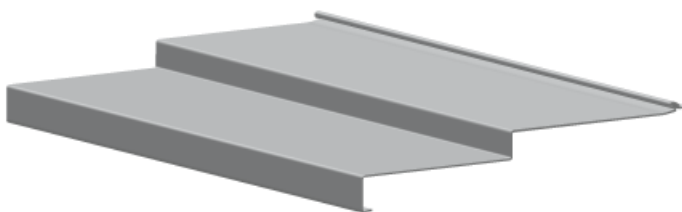

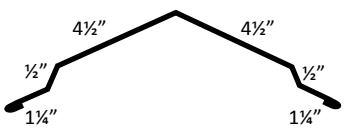
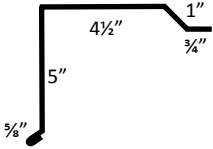
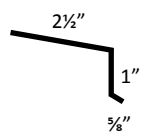
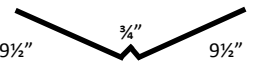
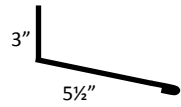
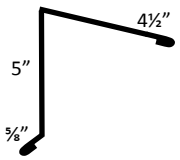
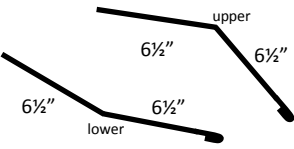
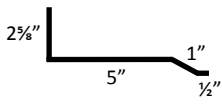
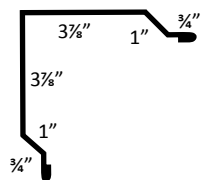
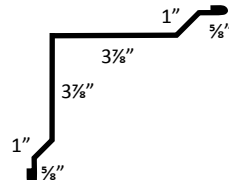
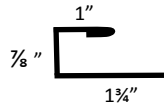
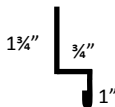
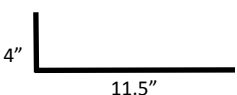
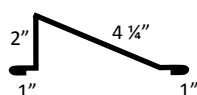
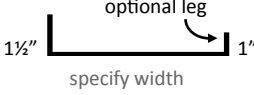
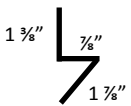
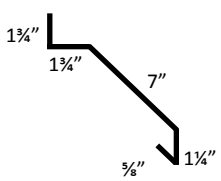
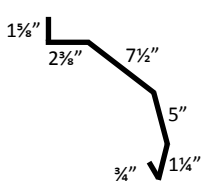
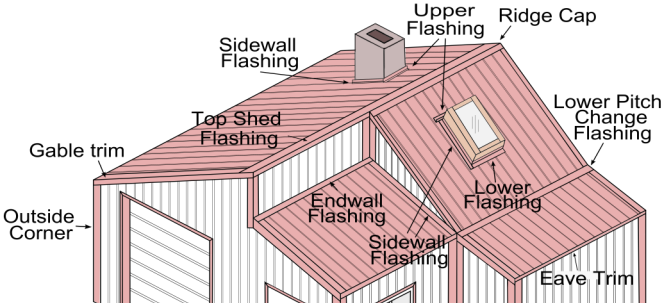
<b>RIDGE CAP *</b> 9:12 or > pitch needs more reach added  SKU TRRI	<b>GABLE TRIM</b>  SKU TRG	<b>EAVE TRIM *</b>  SKU TREV	<b>W VALLEY *</b> Specify both pitches (if required)  SKU TRWV						
<b>ENDWALL TRIM *</b>  SKU TREW	<b>TOP SHED *</b>  SKU TRTOP	<b>PITCH CHANGE*</b> Specify both pitches  <table border="1"> <tr> <td>TRPCU</td> <td>UPPER</td> </tr> <tr> <td>TRPCL</td> <td>LOWER</td> </tr> </table> SKU	TRPCU	UPPER	TRPCL	LOWER	<b>SIDEWALL</b>  SKU TRSW		
TRPCU	UPPER								
TRPCL	LOWER								
<b>OUTSIDE CORNER</b>  SKU TRCO	<b>INSIDE CORNER</b>  SKU TRCI	<b>C CASING</b>  SKU TRCC	<b>WALL TO LIGHT</b>  SKU TRWL						
<b>UPPER FLASH *</b>  SKU TRUF	<b>SNOW BREAK</b>  SKU TRSB	<b>JAMB CAP</b> optional leg specify width  <table border="1"> <tr> <td>TRJ5</td> <td>5 5/8"</td> </tr> <tr> <td>TRJ7</td> <td>7 5/8"</td> </tr> <tr> <td>TRJ9</td> <td>9 5/8"</td> </tr> </table> SKU	TRJ5	5 5/8"	TRJ7	7 5/8"	TRJ9	9 5/8"	<b>RODENT GUARD</b>  SKU TRRO
TRJ5	5 5/8"								
TRJ7	7 5/8"								
TRJ9	9 5/8"								
<b>TRACK COVER</b>  SKU TRTC	<b>DOUBLE TRACK COVER</b>  SKU TRTCD								

All trim is in 10'-3" lengths - up to 20'-3" lengths available in 2' increments

\* Specify pitch when ordering

<p><b>PBR RIDGE CAP *</b> <span style="border: 1px dashed orange; padding: 2px;">9:12 or &gt; pitch needs more reach added</span></p> <p><b>SKU</b> <b>TRPRI</b></p>	<p><b>PBR GABLE TRIM</b></p> <p><b>SKU</b> <b>TRPG</b></p>	<p><b>PBR EAVE TRIM *</b></p> <p><b>SKU</b> <b>TRPEV</b></p>	<p><b>W VALLEY *</b> <span style="border: 1px dashed orange; padding: 2px;">Specify both pitches (if required)</span></p> <p><b>SKU</b> <b>TRWV</b></p>						
<p><b>PBR ENDWALL TRIM *</b></p> <p><b>SKU</b> <b>TRPEW</b></p>	<p><b>PBR TOP SHED *</b></p> <p><b>SKU</b> <b>TRPTOP</b></p>	<p><b>PITCH CHANGE *</b> <span style="border: 1px dashed orange; padding: 2px;">Specify both pitches</span></p> <table border="1" style="margin-left: auto; margin-right: auto;"> <tr> <td><b>TRPCU</b></td> <td><b>UPPER</b></td> </tr> <tr> <td><b>TRPCL</b></td> <td><b>LOWER</b></td> </tr> </table> <p><b>SKU</b></p>	<b>TRPCU</b>	<b>UPPER</b>	<b>TRPCL</b>	<b>LOWER</b>	<p><b>PBR SIDEWALL</b></p> <p><b>SKU</b> <b>TRPSW</b></p>		
<b>TRPCU</b>	<b>UPPER</b>								
<b>TRPCL</b>	<b>LOWER</b>								
<p><b>PBR OUTSIDE CORNER</b></p> <p><b>SKU</b> <b>TRPCO</b></p>	<p><b>PBR INSIDE CORNER</b></p> <p><b>SKU</b> <b>TRPCI</b></p>	<p><b>PBR OPEN C CASING</b></p> <p><b>SKU</b> <b>TRPCCO</b></p>	<p><b>PBR CLOSED C CASING</b></p> <p><b>SKU</b> <b>TRPCC</b></p>						
<p><b>PBR WALL TO LIGHT</b></p> <p><b>SKU</b> <b>TRPWL</b></p>	<p><b>PBR BASE TRIM</b></p> <p><b>SKU</b> <b>TRPB</b></p>	<p><b>PBR JAMB CAP</b></p> <table border="1" style="margin-left: auto; margin-right: auto;"> <tr> <td><b>TRPJ6</b></td> <td><b>6"</b></td> </tr> <tr> <td><b>TRPJ8</b></td> <td><b>8"</b></td> </tr> <tr> <td><b>TRPJ10</b></td> <td><b>10"</b></td> </tr> </table> <p><b>SKU</b></p>	<b>TRPJ6</b>	<b>6"</b>	<b>TRPJ8</b>	<b>8"</b>	<b>TRPJ10</b>	<b>10"</b>	<p><b>PBR RODENT GUARD</b></p> <p><b>SKU</b> <b>TRPRO</b></p>
<b>TRPJ6</b>	<b>6"</b>								
<b>TRPJ8</b>	<b>8"</b>								
<b>TRPJ10</b>	<b>10"</b>								
<p><b>TRACK COVER</b></p> <p><b>SKU</b> <b>TRTC</b></p>	<p><b>DOUBLE TRACK COVER</b></p> <p><b>SKU</b> <b>TRTCD</b></p>	<p><b>PBR FORMED RIDGE *</b></p> <p>36" x 36" coverage</p> <p><b>SKU</b> <b>TRP26RIF</b></p>	<p>Custom trim available Contact us for details</p>						

All trim is in 10'-3" lengths - up to 20'-3" lengths available in 2' increments

\* Specify pitch when ordering

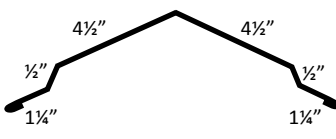
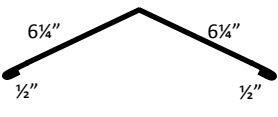
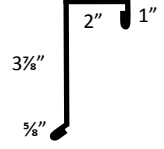
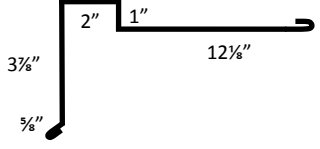
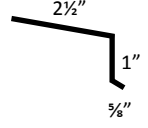
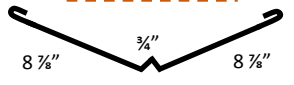
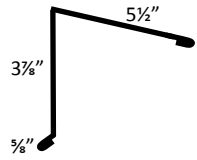
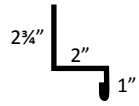
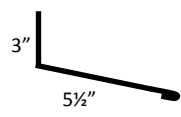
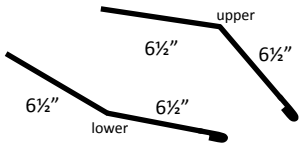
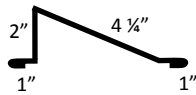
<b>RIDGE CAP*</b> 9:12 or > pitch needs more reach added  <b>SKU TRRI</b>	<b>HIP CAP *</b> 9:12 or > pitch needs more reach added  <b>SKU TRH</b>	<b>LOC SEAM GABLE</b>  <b>SKU TRLG</b>	<b>PROW GABLE TRIM</b>  <b>SKU TRLPR</b>			
<b>EAVE TRIM *</b>  <b>SKU TREV</b>	<b>LOC SEAM W VALLEY *</b> Specify both pitches (if required)  <b>SKU TRLWV</b>	<b>LOC SEAM TOP SHED *</b>  <b>SKU TRLT</b>	<b>LOC SEAM SIDEWALL</b>  <b>SKU TRLSW</b>			
<b>ENDWALL TRIM *</b>  <b>SKU TREW</b>	<b>PITCH CHANGE *</b> Specify both pitches  <table border="1" data-bbox="592 1081 803 1155"> <tr> <td>TRPCU</td> <td>UPPER</td> </tr> <tr> <td>SKU TRPCL</td> <td>LOWER</td> </tr> </table>	TRPCU	UPPER	SKU TRPCL	LOWER	<b>SNOW BREAK</b>  <b>SKU TRSB</b>
TRPCU	UPPER					
SKU TRPCL	LOWER					

All trim is in 10'-3" lengths - up to 20'-3" lengths available in 2' increments

\* Specify pitch when ordering

**CHIMNEY & SKYLIGHT FLASHING**

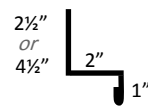
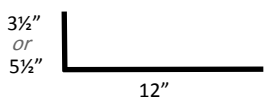
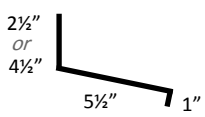
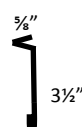
<b>SIDEWALL</b>  specify curb height <b>SKU TRLSKS</b>	<b>UPPER FLASH *</b>  specify curb height <b>SKU TRLSKU</b>	<b>LOWER FLASH *</b>  specify curb height <b>SKU TRLSKL</b>	<b>CHIMNEY COUNTERFLASH</b>  <b>SKU TRLSKC</b>
--	---	--	---

All trim is in 10'-3" lengths - up to 20'-3" lengths available in 2' increments

\* Specify pitch when ordering

**ALL LISTED DIMENSIONS TYPICAL**

**DIMENSIONS CUSTOMIZABLE UPON REQUEST**

All trim is in 10'-3" lengths - up to 20'-3" lengths available in 2' increments

\* Specify pitch when ordering

**FASCIA GABLE**

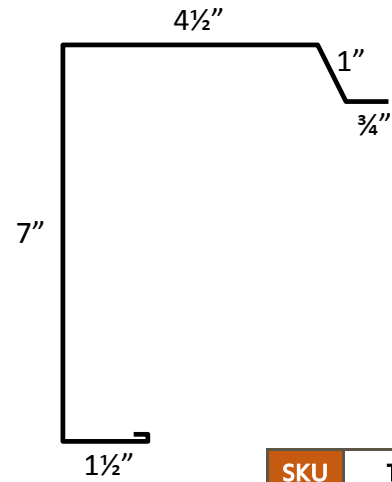

<b>SKU</b>	<b>TRFG</b>
------------	-------------

**PITCH SOFFIT\***

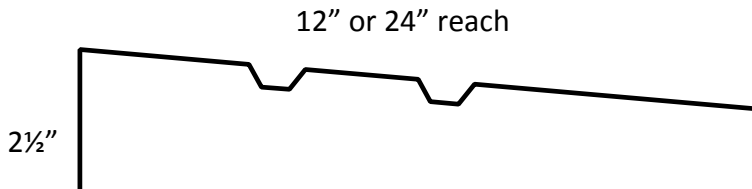

<b>REACH</b>	<b>12"</b>	<b>24"</b>
<b>SKU</b>	<b>TRS12</b>	<b>TRS24</b>

**PITCH FASCIA\***

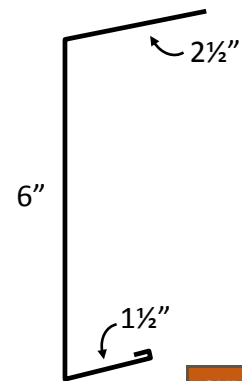

<b>SKU</b>	<b>TRFE</b>
------------	-------------

**PARALLEL SOFFIT**

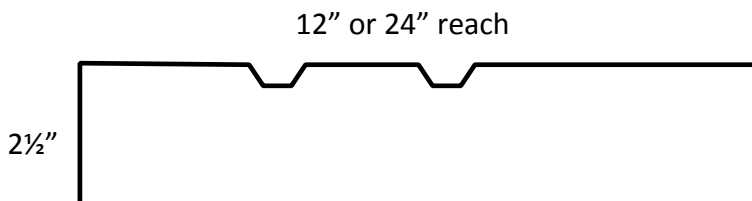

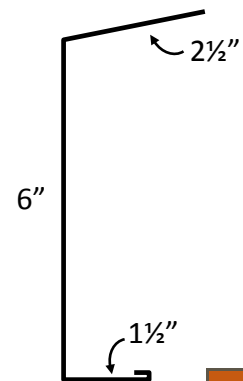

<b>REACH</b>	<b>12"</b>	<b>24"</b>
<b>SKU</b>	<b>TRS12</b>	<b>TRS24</b>

**PARALLEL FASCIA\***



<b>SKU</b>	<b>TRFE</b>
------------	-------------

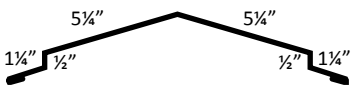
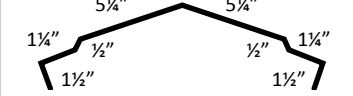
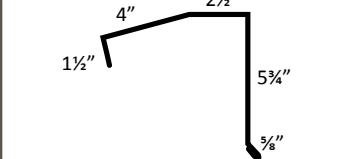
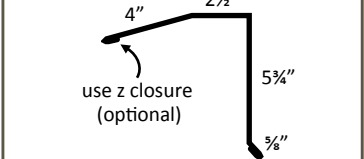
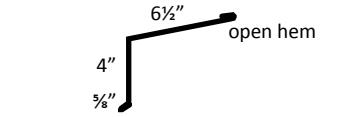
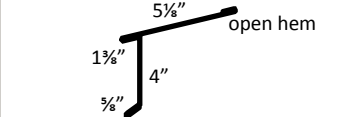
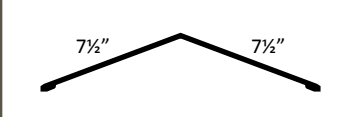
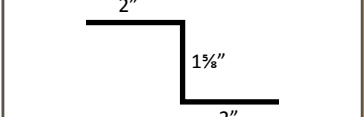
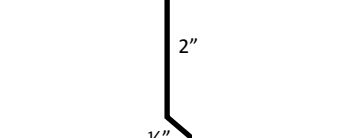
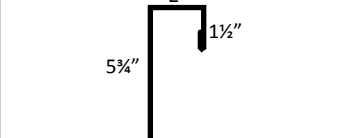
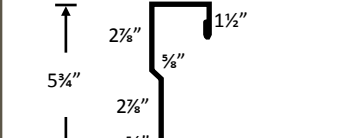
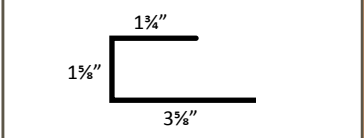
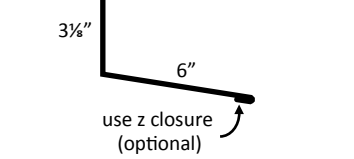
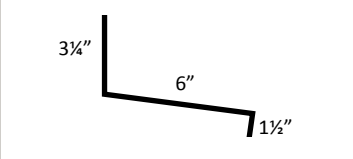
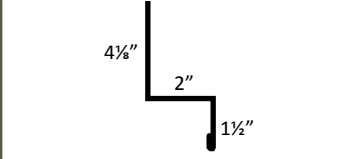
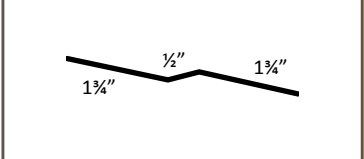
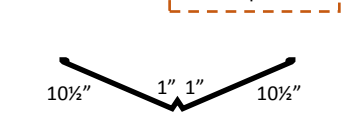

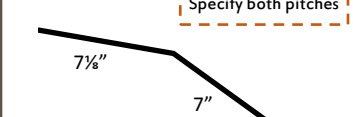
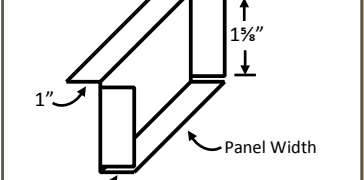
<p><b>RIDGE CAP*</b></p>  <p>9:12 or &gt; pitch needs more reach added</p> <p><b>SKU</b> TRM1RI</p>	<p><b>CLOSED RIDGE/HIP *</b></p>  <p>9:12 or &gt; pitch needs more reach added</p> <p><b>SKU</b> TRM1RIC</p>	<p><b>CLOSED TOP SHED *</b></p>  <p><b>SKU</b> TRM1TOPC</p>	<p><b>TOP SHED *</b></p>  <p>use z closure (optional)</p> <p><b>SKU</b> TRM1TOP</p>
<p><b>EAVE TRIM *</b></p>  <p>open hem</p> <p><b>SKU</b> TRM1EV</p>	<p><b>EXTENDED EAVE *</b></p>  <p>open hem</p> <p><b>SKU</b> TRM1EEV</p>	<p><b>HIP CAP *</b></p>  <p><b>SKU</b> TRM1H</p>	<p><b>Z CLOSURE</b></p>  <p><b>SKU</b> TRM1Z</p>
<p><b>TRIM CLEAT</b></p>  <p><b>SKU</b> TRM1TC</p>	<p><b>GABLE TRIM</b></p>  <p><b>SKU</b> TRM1G</p>	<p><b>SCULPTURED GABLE TRIM</b></p>  <p><b>SKU</b> TRM1GS</p>	<p><b>GABLE/SIDEWALL SUPPORT</b></p>  <p><b>SKU</b> TRM1GSS</p>
<p><b>ENDWALL TRIM *</b></p>  <p>use z closure (optional)</p> <p><b>SKU</b> TRM1EW</p>	<p><b>CLOSED ENDWALL TRIM *</b></p>  <p><b>SKU</b> TRM1EWC</p>	<p><b>SIDEWALL</b></p>  <p><b>SKU</b> TRM1SW</p>	<p><b>OFFSET CLEAT</b></p>  <p><b>SKU</b> TRM1OC</p>
<p><b>W VALLEY *</b></p> <p>Specify both pitches (if required)</p>  <p><b>SKU</b> TRM1WV</p>	<p><b>CLOSED LOWER PITCH CHANGE *</b></p> <p>Specify both pitches</p>  <p><b>SKU</b> TRM1PCL</p>	<p><b>CLOSED UPPER PITCH CHANGE *</b></p> <p>Specify both pitches</p>  <p><b>SKU</b> TRM1PCU</p>	<p><b>METAL CLOSURE</b></p>  <p>Panel Width</p> <p><b>SKU</b> TRM1MC</p>

All trim is in 10'-3" lengths - up to 20'-3" lengths available in 2' increments

\* Specify pitch when ordering

<p><b>RIDGE CAP *</b></p> <p>SKU TRM2RI</p>	<p><b>CLOSED RIDGE/HIP *</b></p> <p>SKU TRM2RIC</p>	<p><b>CLOSED TOP SHED *</b></p> <p>SKU TRM2TOPC</p>	<p><b>TOP SHED *</b></p> <p>SKU TRM2TOP</p>
<p><b>EAVE TRIM *</b></p> <p>SKU TRM2EV</p>	<p><b>EXTENDED EAVE *</b></p> <p>SKU TRM2EEV</p>	<p><b>HIP CAP *</b></p> <p>SKU TRM2H</p>	<p><b>Z CLOSURE</b></p> <p>SKU TRM2Z</p>
<p><b>TRIM CLEAT</b></p> <p>SKU TRM2TC</p>	<p><b>GABLE TRIM</b></p> <p>SKU TRM2G</p>	<p><b>SCULPTURED GABLE TRIM</b></p> <p>SKU TRM2GS</p>	<p><b>GABLE/SIDEWALL SUPPORT</b></p> <p>SKU TRM2GSS</p>
<p><b>ENDWALL TRIM *</b></p> <p>SKU TRM2EW</p>	<p><b>CLOSED ENDWALL TRIM *</b></p> <p>SKU TRM2EWC</p>	<p><b>SIDEWALL</b></p> <p>SKU TRM2SW</p>	<p><b>OFFSET CLEAT</b></p> <p>SKU TRM2OC</p>
<p><b>W VALLEY *</b></p> <p>Specify both pitches (if required)</p> <p>SKU TRM2WV</p>	<p><b>CLOSED LOWER PITCH CHANGE *</b></p> <p>Specify both pitches</p> <p>SKU TRM2PCL</p>	<p><b>CLOSED UPPER PITCH CHANGE *</b></p> <p>Specify both pitches</p> <p>SKU TRM2PCU</p>	<p><b>METAL CLOSURE</b></p> <p>SKU TRM2MC</p>

All trim is in 10'-3" lengths - up to 20'-3" lengths available in 2' increments

\* Specify pitch when ordering

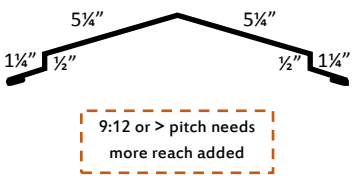
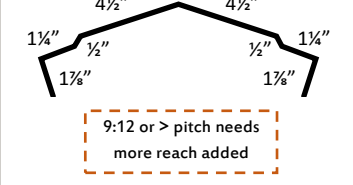
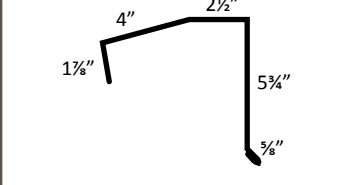
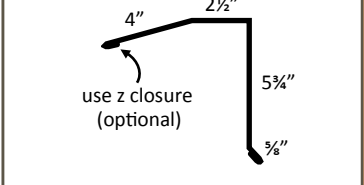
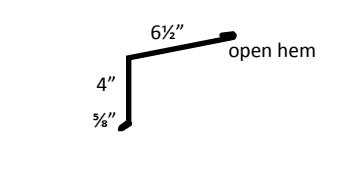
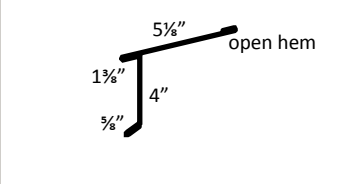
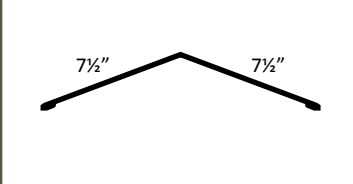
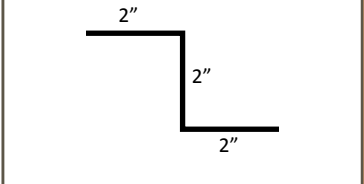
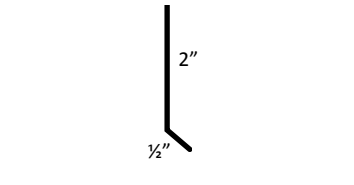
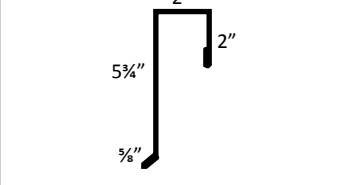
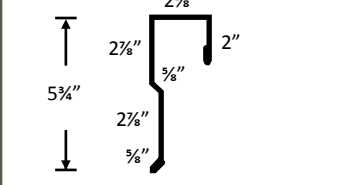
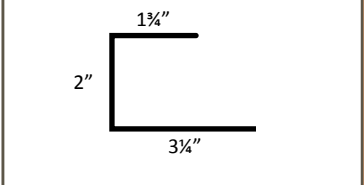
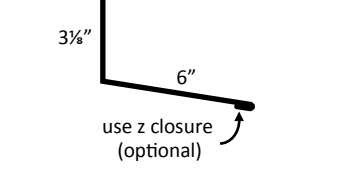
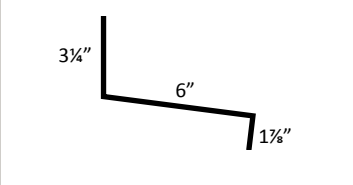
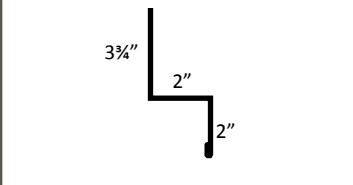
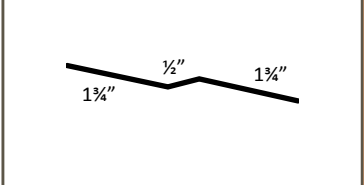
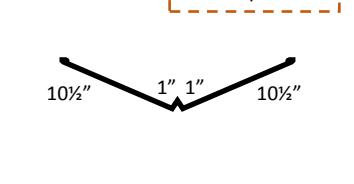
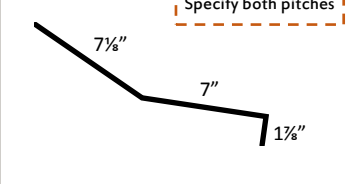
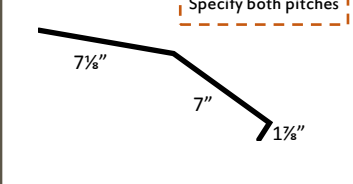
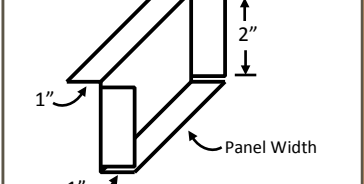
<p><b>RIDGE CAP*</b></p>  <p>9:12 or &gt; pitch needs more reach added</p> <p><b>SKU TRCRI</b></p>	<p><b>CLOSED RIDGE/HIP *</b></p>  <p>9:12 or &gt; pitch needs more reach added</p> <p><b>SKU TRCRIC</b></p>	<p><b>CLOSED TOP SHED *</b></p>  <p><b>SKU TRCTOPC</b></p>	<p><b>TOP SHED *</b></p>  <p>use z closure (optional)</p> <p><b>SKU TRCTOP</b></p>
<p><b>EAVE TRIM *</b></p>  <p>open hem</p> <p><b>SKU TRCEV</b></p>	<p><b>EXTENDED EAVE *</b></p>  <p>open hem</p> <p><b>SKU TRCEEV</b></p>	<p><b>HIP CAP *</b></p>  <p><b>SKU TRCH</b></p>	<p><b>Z CLOSURE</b></p>  <p><b>SKU TRCZ</b></p>
<p><b>TRIM CLEAT</b></p>  <p><b>SKU TRCTC</b></p>	<p><b>GABLE TRIM</b></p>  <p><b>SKU TRCG</b></p>	<p><b>SCULPTURED GABLE TRIM</b></p>  <p><b>SKU TRCGS</b></p>	<p><b>GABLE/SIDEWALL SUPPORT</b></p>  <p><b>SKU TRCGSS</b></p>
<p><b>ENDWALL TRIM *</b></p>  <p>use z closure (optional)</p> <p><b>SKU TRCEW</b></p>	<p><b>CLOSED ENDWALL TRIM *</b></p>  <p><b>SKU TRCEWC</b></p>	<p><b>SIDEWALL</b></p>  <p><b>SKU TRCSW</b></p>	<p><b>OFFSET CLEAT</b></p>  <p><b>SKU TRCOC</b></p>
<p><b>W VALLEY *</b></p> <p>Specify both pitches (if required)</p>  <p><b>SKU TRCWW</b></p>	<p><b>CLOSED LOWER PITCH CHANGE *</b></p> <p>Specify both pitches</p>  <p><b>SKU TRCPL</b></p>	<p><b>CLOSED UPPER PITCH CHANGE *</b></p> <p>Specify both pitches</p>  <p><b>SKU TRPCU</b></p>	<p><b>METAL CLOSURE</b></p>  <p>Panel Width</p> <p><b>SKU TRCMC</b></p>

All trim is in 10'-3" lengths - up to 20'-3" lengths available in 2' increments

\* Specify pitch when ordering

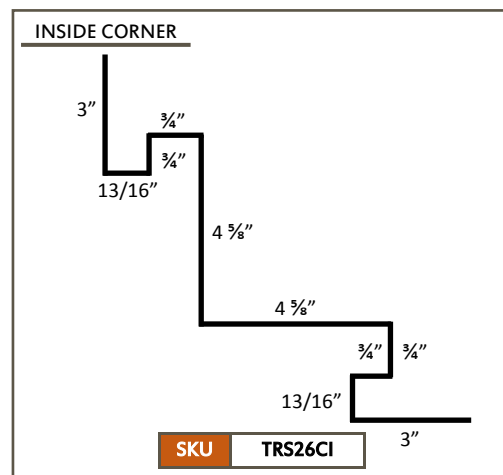
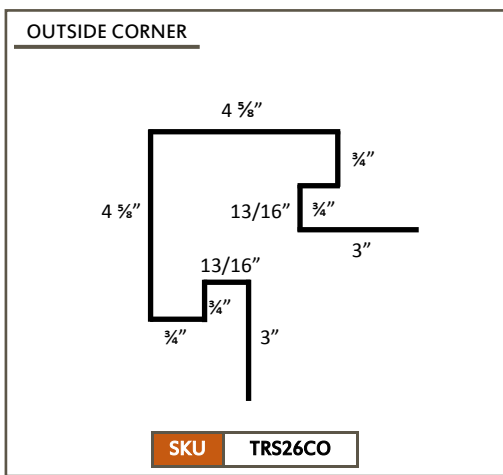
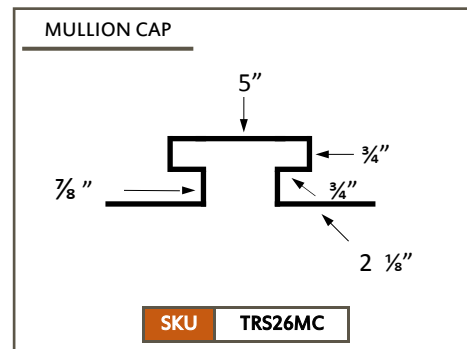
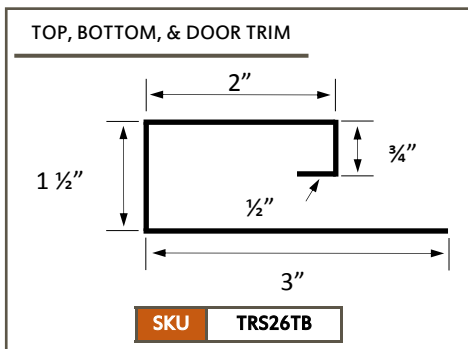
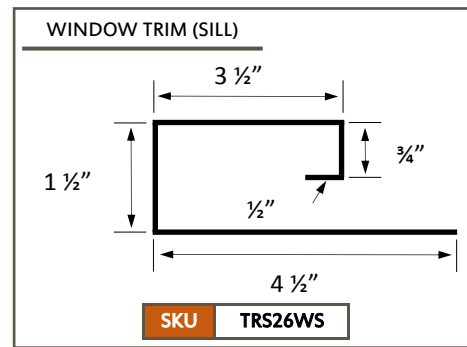
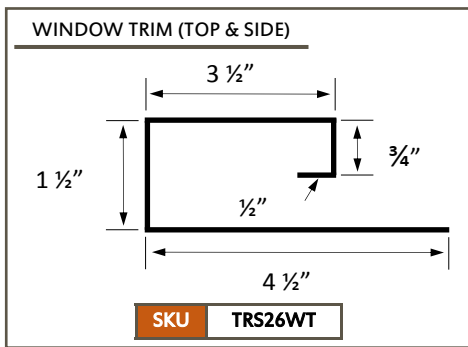
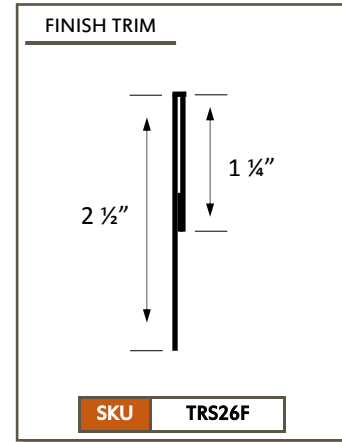
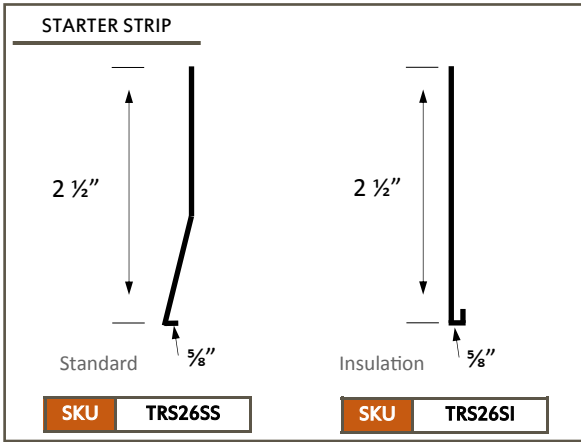

Standard Length for Siding Trim: 12'-3"



- 24 gauge smooth steel panel, baked-on white enamel finish coat
- Pre-painted aluminum frame (white)
- 3 ½" Pre-hung 4-way universal swing jamb system
- Polyurethane foam core, R-value 12
- Full perimeter weather stripping, 3 stainless steel fixed pin hinges, and keyed lockset included
- Window options available

**SERIES 94**

SKU	Door		Rough Opening	
	Width	Height	Width	Height
PDR9436	3'-0"	6'-8"	40 ½"	82 ¼"
PDR9448	4'-0"	6'-8"	52 ½"	82 ¼"
PDR9472	6'-0"	6'-8"	77 ¾"	82 ¼"



- Painted 16 gauge steel frame (polar white)
- 26 gauge smooth steel skin, baked-on polar white finish coat
- 3 ½" Pre-hung 4-way universal swing jamb system
- Polyurethane foam core, R-value 13
- Full perimeter weather stripping, 3 stainless steel fixed pin hinges, and keyed lockset included

**SERIES 95**

SKU	Door		Rough Opening	
	Width	Height	Width	Height
PDR9536	3'-0"	6'-8"	38 ½"	81 ¾"
PDR9548	4'-0"	6'-8"	50 ½"	81 ¾"
PDR9572	6'-0"	6'-8"	75 ⅝"	81 ¾"



## ENTRY DOORS

"Your Metal Panel Manufacturer and Building Supplier!"



- 26 gauge smooth steel skin, baked-on polar white finish coat
- High tensile aluminum frame
- 3 ½" Pre-hung 4-way universal swing jamb system
- Polyurethane foam core, R-value 13
- Full perimeter weather stripping, 3 stainless steel fixed pin hinges, and keyed lockset included
- Optional fixed pin hinges for extra security



SKU	Door		Rough Opening	
	Width	Height	Width	Height
PDR9936	3'-0"	6'-8"	38 ½"	82 ¼"
PDR9948	4'-0"	6'-8"	50 ½"	82 ¼"
PDR9972	6'-0"	6'-8"	75 ½"	82 ¼"

### SERIES 99

## ARCADIAN DUTCH DOORS

- Fabricated from 16 gauge Galvanneal
- Feature one-piece cut laser design
- Standard D-Latch
- 3-piece frame prepped with hinges

Assembled Premium Dutch & Bale doors include the following components:

- One piece laser cut door panels
- Cross bucks
- 29 gauge steel insert
- Plywood core
- Hinges
- Barrel bolt
- D-Latch
- Door Catch
- Fasteners



Description	Rough Opening		SKU	
	Width	Height	Standard	Windows
Dutch Door	49 ⅛"	87 ½"	MWDDS	MWDDW
Bale Door	49 ⅛"	43 ¾"	MWBDS	MWBDW

### DUTCH & BALE DOORS

<p><b>ROUND TRACK SIDEMOUNT</b></p>  <p>AVAILABLE LENGTHS 8', 10', 12', 14'</p> <p>SKU <b>DRRTRK</b></p>	<p><b>ROUND TRACK STUDBOLT</b></p>  <p>AVAILABLE LENGTHS 8', 10', 12', 14'</p> <p>SKU <b>DRRTRKSB</b></p>	<p><b>TROLLEY SET 9" OFFSET BOLT</b></p>  <p>600 LBS RATING</p> <p>SKU <b>DRRTR09</b></p>	<p><b>SPLICE COLLAR</b></p>  <p>SKU <b>DRSCOL</b></p>
<p><b>DOUBLE TRACK SUPPORT W/ WELDED BRACKET</b></p>  <p>SKU <b>DRDBLTSUPP</b></p>	<p><b>DOUBLE TRACK SUPPORT</b></p>  <p>SKU <b>DRDBLBR</b></p>	<p><b>TRACK COVER BRACKET STANDARD</b></p>  <p>SKU <b>DRTCBRAC</b></p>	<p><b>DOOR PULL WHITE</b></p>  <p>SKU <b>DRDPULL</b></p>
<p><b>DOOR STOP NON-ADJUSTABLE</b></p>  <p>SKU <b>DRNASTOP</b></p>	<p><b>DOOR STOP ADJUSTABLE</b></p>  <p>SKU <b>DRASTOP</b></p>	<p><b>SIDE RAIL WHITE ALUMINUM</b></p>  <p>AVAILABLE LENGTHS 8', 10', 12', 14', 16'</p> <p>SKU <b>DRSSRAIL</b></p>	<p><b>SIDE RAIL W/ ADAPTER WHITE ALUMINUM</b></p>  <p>AVAILABLE LENGTHS 8', 10', 12', 14'</p> <p>SKU <b>DRSSRAILW/AD</b></p>
<p><b>GATE HOOK 6"</b></p>  <p>SKU <b>DRGHOOK</b></p>	<p><b>LATCH SLIDING BOLT</b></p>  <p>SKU <b>DRSBLATCH</b></p>	<p><b>LATCH CAM</b></p>  <p>ADJUSTABLE CAM ACTION</p> <p>SKU <b>DRCLATCH</b></p>	<p><b>CANE BOLT 12"</b></p>  <p>SKU <b>DRCBOLT</b></p>
<p><b>STAY ROLLER ADJUSTABLE OFFSET</b></p>  <p>SKU <b>DRAOSTAY</b></p>	<p><b>STAY ROLLER SMALL ADJUSTABLE</b></p>  <p>SKU <b>DRSASTAY</b></p>	<p><b>DOOR GUIDE BI-PASS</b></p>  <p>SKU <b>DRBIGUIDE</b></p>	

- C-2400 steel sectional door designed for moderate commercial use
- Nominal 24 gauge steel construction, 2" thick x 3" wide box-stiles
- Economical and trouble-free operation
- Standard white smooth finish
- Optional R 7.6 Insulated panels with poly laminate back available (30 gauge steel back option available)
- Hi-lift, vertical lift, and roof pitch track available
- Low headroom radius track available down to 7" clearance
- Additional options available, please contact us for additional information
- Manufactured by Wayne Dalton — Made in USA



## MODEL 2400

- C-24 steel sectional door, high strength for heavy-duty use
- True 24 gauge steel construction, 2" thick x 3" wide box-stiles
- Standard white smooth finish
- Optional R 7.6 Insulated panels with poly laminate back available (30 gauge steel back option available)
- Hi-lift, vertical lift, and roof pitch track available
- Low headroom radius track available down to 7" clearance
- Additional options available, please contact us for additional information
- Manufactured by Wayne Dalton — Made in USA



## MODEL 24 GAUGE



- Embossed, 25 gauge steel panels
- 15-year paint system standard
- Five factory-finished color options
- Tongue-and-groove section joints
- 2" thick frame construction
- Woodgrain textured; short and long raised panel designs available
- Wide variety of window options available
- Contact us regarding available sizing options
- Manufactured by Clopay® — Made in USA

### MODEL T50

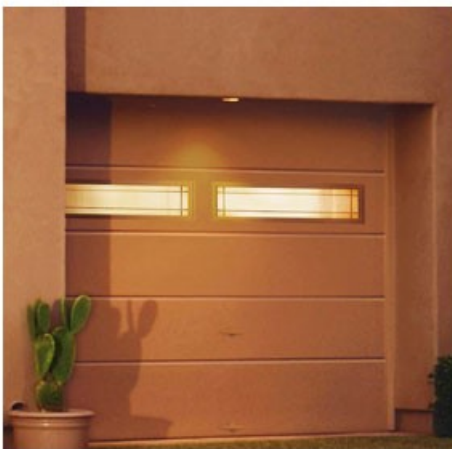

- Embossed 25 gauge steel panels
- 15-year paint system standard
- Five factory-finished color options
- Tongue-and-groove section joints
- 2" thick frame construction
- Woodgrain textured
- Short and long raised panel designs available
- Wide variety of window options available
- 1-5/16", R 6.3, polystyrene vinyl-backed insulation
- Contact us regarding available sizing options
- Manufactured by Clopay® — Made in USA

### MODEL T52 (Insulated)



- Sheet metal to sheet metal screw
- Used for side lap, ridge cap, and fastening various other trim pieces
- Control seal washer for a consistent, weather tight seal
- Weather coating for supreme corrosion resistance
- Stocked in plain (galvanized) and all of our standard paint colors

**STITCHERS**

SKU	Diameter	Length	Quantity	Head Size
ST	#12	¾"	250	¼" Hex



- Control seal washer for a consistent, weather tight seal
- Weather coating for supreme corrosion resistance
- Stocked in plain (galvanized) and all of our standard paint colors (not every size in stock)

SKU	Diameter	Length	Quantity	Head Size
SC1	#9	1"	250	¼" Hex
SC1.5	#9	1 ½"	250	¼" Hex
SC2	#9	2"	250	¼" Hex
SC2.5	#9	2 ½"	250	¼" Hex
SC3	#9	3"	250	¼" Hex

**ROOF & WALL**

- Designed for areas where a low profile is essential
- Recommended for our concealed fastener panels
- Weather coating for supreme corrosion resistance

SKU	Diameter	Length	Quantity	Head Size
SCULT1	#10	1"	250	#2 Square
SCULT1.5	#10	1 ½"	250	#2 Square

**ULTRA LOW PROFILE**

- Special washer designed for fixing polycarbonate skylight panels
- Weather coating for supreme corrosion resistance

SKU	Diameter	Length	Quantity	Head Size
SCPOLY1	#9	1"	250	¼" Hex
SCPOLY1.5	#9	1 ½"	250	¼" Hex

**POLYSEAL (WOOD)**

- Used for pan fixing steel panels on walls and roofs
- Has  $\frac{9}{16}$ " outside diameter washer and rubber seal
- Weather coating for supreme corrosion resistance
- Stocked in plain (galvanized) and a variety of paint colors



## ROOF & WALL (PAN FIXING)

SKU	Diameter	TPI	Length	Tip	Quantity	Head Size
SDHB3121425	#12	14	1"	T3	250	$\frac{5}{16}$ " Hex
SDHB3121440	#12	14	1 1/2"	T3	250	$\frac{5}{16}$ " Hex

- Used for crest fixing steel panels on the roof
- Has  $\frac{9}{16}$ " outside diameter washer and rubber seal
- Secondary thread under shank pulls metal upward preventing any water penetration
- Weather coating for supreme corrosion resistance
- Stocked in plain (galvanized) and a variety of paint colors



## ROOF (CREST FIXING)

SKU	Diameter	TPI	Length	Tip	Quantity	Head Size
SDHKN4121445	#12	14	1 7/8"	T3	250	$\frac{5}{16}$ " Hex
SDHKN4121455	#12	14	2 3/8"	T3	250	$\frac{5}{16}$ " Hex
SDHKN4121468	#12	14	3 1/4"	T3	To Order	$\frac{5}{16}$ " Hex

- Stitching screw used for sheet to sheet fastening
- Ideal for bonding lap seams in light gauge panels
- Weather coating for supreme corrosion resistance
- Stocked in plain (galvanized) and a variety of paint colors



## LAP SCREWS

SKU	Diameter	TPI	Length	Tip	Quantity	Head Size
SSHN3121420	#14	14	7/8"	T1	250	$\frac{5}{16}$ " Hex



- Used for fastening heavy duty structural framing
- Weather coating for supreme corrosion resistance

**FRAMING (Heavy Duty)**

SKU	Diameter	TPI	Length	Tip	Quantity	Head Size
SDH83142025	#14	14	1"	T3	500	3/8" Hex



- Used for fastening medium duty structural framing (doors & windows)
- Weather coating for supreme corrosion resistance

**FRAMING (Medium Duty)**

SKU	Diameter	TPI	Length	Tip	Quantity	Head Size
LDSF121434	#12	14	3/4"	T2	250	5/16" Hex



- Tek Series 5 Driller
- Used for drilling through thick or multiple layers of steel
- Ideal for double knee and apex bracing
- Weather coating for supreme corrosion resistance

**FRAMING (T-5)**

SKU	Diameter	TPI	Length	Tip	Quantity	Head Size
S5H3142432	#14	24	1 1/2"	T5	50	3/8" Hex



- Designed for attaching wood to structural steel
- Special ribbed head seats itself flush into the wood for easy top finishing
- Ideal for putting sub flooring on steel mezzanines
- Weather coating for supreme corrosion resistance

SKU	Diameter	TPI	Length	Tip	Quantity	Head Size
WDCPH3101645	#10	16	1 7/16"	T3	To Order	#2 Philips
WDCPH3101655	#10	16	2 1/4"	T3	To Order	#2 Philips
WDCPH3101675	#10	16	3"	T3	To Order	#2 Philips



## WING DRILLER

- Designed for areas where a low profile is essential
- Recommended for attaching C-casing to allow panels to slide into the trim without hanging up on a traditional hex head
- Weather coating for supreme corrosion resistance
- Stocked in plain (galvanized)

SKU	Diameter	TPI	Length	Tip	Quantity	Head Size
SCPKD5/8	#10	16	5/8"	T2	To Order	#2 Philips
SCPKD	#12	16	1"	T2	To Order	#2 Philips



## PANCAKE HEAD

- Special washer designed for crest fixing polycarbonate skylight panels
- Weather coating for supreme corrosion resistance

SKU	Diameter	TPI	Length	Tip	Quantity	Head Size
SDHP3121445	#12	14	1 3/4"	T3	250	5/16" Hex
SDHP3121455	#12	14	2 1/4"	T3	250	5/16" Hex



## POLYSEAL (STEEL)

- Provides a low visibility trim connection
- Suited for downspouts, gutters and corner trim
- Available in galvanized or a variety of colors

SKU	Size	Quantity
RDAS403	1/8" x 5/16"	To Order



## RIVETS

**CONCRETE SPIKE**

- Patented, one-piece, tamper resistant anchor
- Formed with an "S" shaped configuration to create an expansion mechanism
- Use for base angles and door jamb base brackets

SKU	Diameter	Length	Quantity
SMHZ06025	¼"	1"	500

**WEDGE BOLT PLUS**

- A one-piece, heavy duty anchor for use in concrete, block or brick
- Features a finished hex head, integral washer, and a patented dual thread and chamfered tip
- Requires matched tolerance Wedge Bit
- Dip wedge bolt into lubricating oil prior to installation

SKU	Diameter	Length	Quantity
WBBT12250	½"	2 ½"	To Order
WBBT12300	½"	3"	To Order
WBBT12400	½"	4"	To Order
WBBT12500	½"	5"	To Order
WBBT16500	5/8 "	5"	To Order

**FRAME BOLT ASSEMBLIES**

**FLANGED BOLT & NUT**

- The assembly has a flanged head and bolt, no washers needed
- Conforms to ASTM A307 specifications

SKU	Diameter	Length	Quantity	Head Size
PLCZ58114	5/8 "	1 ¼"	40	15/16" Hex

**30 LBS FELT (ASTM)**

- Manufactured from premium quality organic mat and saturated with high-grade asphalt
- Approximate weight per roll is 50 lbs

SKU	Width	Length	Coverage
F#30ASTM	3'	72'	200 sq ft

**30 LBS FELT (NON-ASTM)**

- Manufactured from premium quality organic mat and saturated with high-grade asphalt
- Approximate weight per roll is 28 lbs

SKU	Width	Length	Coverage
F#30	3'	72'	200 sq ft

**30 LBS SYNTHETIC (ASTM)**

- Hybrid technology combines asphaltic polymer & synthetic fabrics
- Slip-resistant
- Meets or exceeds ASTM D226 requirements
- Thermal stability in excess of 260 F
- Approximate weight per roll is 50 lbs

SKU	Width	Length	Coverage
SAFEG30	3.1'	145'	425 sq ft

**ICE & WATER SHIELD**

- Peel & stick underlayment with 6 month exposure rating
- High temp rating, up to 240°F—30 year limited warranty
- Woven poly scrim, non-abrasive surface, with good walkability
- Approximate weight per roll is 50 lbs (40 mil nominal thickness)

SKU	Width	Length	Coverage
ICE	3'	72'	200 sq ft

# INSULATION

"Your Metal Panel Manufacturer and Building Supplier!"



- Non-toxic, no fiberglass
- Seals tight around fasteners with certified ASTM testing
- Microcell polyethylene foam construction
- Improves energy efficiency
- Vapor barrier and thermal break all in one



SKU	Width	Length	Lap Type	R-Value (varies by application)
ESPMICRO	4'	100'	Staple Flange	R-7 to R-10
ESPLOWE	4'	100'	EZ Seal Tape Flange	Up to R-11

## FOIL INSULATION

- Fiberglass insulation bonded to white reinforced vinyl backing
- Insulates against the cold
- Eliminates condensation and drafts, reduces noise
- 6' x 100' rolls of 1.5" thick stocked
- Available in custom lengths (with lead time)



SKU	Width	Max Length	R-Value	Thickness
PVACCB1.5	4' or 6'	100'	R3-R4	1 1/2"
INSWMPVRR10	4' or 6'	100'	R10	3"
INSWMPVRR13	4' or 6'	75'	R13	4"
INSWMPVRR19	4' or 6'	50'	R19	6"

## CONDENSATION CONTROL BLANKET (WMP-VR)

# VAPOR BARRIER

- Excellent choice as an in-wall and roof vapor retarder
- Heavy-duty scrim reinforcement, laminated between two layers of virgin high-strength polyethylene film
- Resists punctures and immediately stops tears
- Accordion folded and tightly rolled on a heavy-duty core for ease of handling and time-saving installation
- UV stabilizers increase longevity

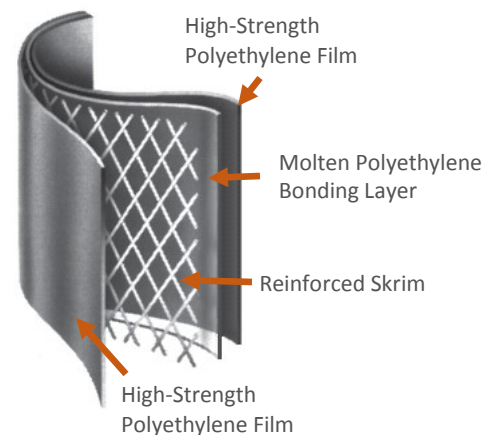

SKU	Width	Length	R-Value	Thickness
VAP600	6'	100'	None	6 mil
VAP1200	12'	100'	None	6 mil

## VAPOR BARRIER

**DOUBLE SIDED TAPE**

- High tack, high adhesion, high shear strength
- Excellent low and elevated temperature performance
- TAPURGL bonds well in high moisture conditions

SKU	Width	Length	Thickness	Application
TAPUR	1 ½"	180'	5 mil	Dry
TAPURGL	1 ½"	180'	5 mil	Wet

**VINYL TAPE**

- Thin, strong, conformable, premium vinyl tape
- Particularly aggressive acrylic adhesive system
- Shrink and plasticizer resistant

SKU	Width	Length	Reinforced
TAVIN	3"	150'	No
TAWMPVR	3"	150'	Yes

**FOIL TAPE**

- Thin, strong, conformable, premium foil tape
- Particularly aggressive acrylic adhesive system
- Shrink and plasticizer resistant

SKU	Width	Length	Reinforced
TAFOI	3"	150'	Yes

**SEALANTS**

**BUTYL CLAY**

- Excellent for sealing edges and seams on metal roofs
- Excellent flexibility over wide temperature ranges
- Long term durability

SKU	Thickness	Width	Length
BCL12	3/32"	½"	50'

# SEALANTS

"Your Metal Panel Manufacturer and Building Supplier!"



- Clear drying, polyether sealant
- Universal sealant good for all seasons
- Sticks to almost anything—Except for Kynar (PVDF) paint
- Apply in all weather, 100% solids will not shrink
- Paintable within 24 hours



SKU	Size
CLEAR	10.1 oz

## CLEAR SEAL

- Sticks to wet surfaces—can be applied in the rain
- UV Resistant mildew & fungus resistant
- Elastomeric for a weatherproof long lasting seal
- Paintable in 24 hours with latex paint



SKU	Size
FLEX	10.6 oz

## FLEXIBLE SEAL

- Silicone sealant/adhesive available in translucent and select colors
- Remains permanently flexible and adheres well to damp surfaces
- Extrudes down to -20° F
- Meets CARB and OTC Regulation (UOC Compliant)
- For both SMP and PVDF paint applications



SKU	Size
NVF	10.3 oz

## NOVA FLEX



- Great for residential or commercial heat vents and stove pipes
- Flexible base can be conformed to virtually any panel profile
- Withstands temperatures from -100° F up to 500° F
- Maximum resistance to UV rays and weathering
- Easy on-site customization

**SILICONE (HIGH TEMP)**

SKU	Size	Pipe Outer Diameter		Base Dimensions	
		Minimum	Maximum	Width	Length
MFHIT4	#4	3"	7"	10"	10"
MFHIT5	#5	4"	8"	11"	11"
MFHIT6	#6	5"	10"	12"	12"
MFHIT7	#7	6"	11"	14"	14"
MFHIT8	#8	7"	13"	17"	17"
MFHIT9	#9	10"	20"	25"	25"



- Great for residential or commercial pipes
- Flexible base can be conformed to virtually any panel profile
- Withstands temperatures up to 212° F
- Maximum resistance to UV rays and weathering
- Easy on-site customization — special order a variety of colors

**EPDM**

SKU	Size	Pipe Outer Diameter		Base Dimensions	
		Minimum	Maximum	Width	Length
MFBLK2	#2	1"	4"	6"	6"
MFBLK3	#3	1/4"	5"	8"	8"
MFBLK4	#4	3"	7"	10"	10"
MFBLK6	#6	5"	10"	12"	12"
MFBLK7	#7	6"	11"	14"	14"
MFBLK8	#8	7"	13"	17"	17"
MFBLK9	#9	10"	20"	25"	25"
MFBLK10	#10	12"	28"	34"	34"



## PIPE FLASHINGS

"Your Metal Panel Manufacturer and Building Supplier!"



- Flexible base can be conformed to virtually any panel profile
- Withstands temperatures up to 212° F
- Maximum resistance to UV rays and weathering
- Easy on-site customization — residential or commercial pipes
- Useful for electrical weather-heads or any location where over-the-top fitting is not an option



SKU	Size	Pipe Outer Diameter		Base Dimensions	
		Minimum	Maximum	Width	Length
MFRET1	#1	1"	4"	8 ¼"	8 ¼"

### EPDM RETROFIT

## VENTING

- A foam closure that allows venting, commonly used below ridge cap
- Made of extremely durable tear-, flame-, and clog-resistant polyester
- Flexible to fit almost any roof panel
- Factory applied glue strip
- 99% recovery after compression
- 40 year warranty & building code compliant



SKU	Profile	Thickness	Width	Length
RVMAG3	Delta Rib & Magna Rib	1"	2"	20'
RVPBR	PBR	1 ½"	2"	25'
RVL12	Loc Seam (12")	1"	2"	12"
RVL16	Loc Seam (16")	1"	2"	16"
RVCLIPLOC	Clip Loc	2"	2"	20'

### RIDGE VENT

- A wire mesh screen excellent for venting a ridge
- Small enough mesh to keep birds and bugs out



SKU	Width	Length
VENT8	8"	100'

### SCREEN VENT



- Will conform to almost any roof panel
- Compresses and fills every void
- Factory applied glue strip

**UNIVERSAL SEAL**

SKU	Thickness	Width	Length
US1125	1"	1 ½"	25'



- Made of ESMP foam
- Resists UV rays
- Blocks moisture/water and bugs

**FORMED CLOSURE**

Profile	SKU		Length
	Inside	Outside	
Corrugated	CLOSCOR		24"
Delta Rib (24")	IDELTA	DELTA	24"
Magna Rib	IMAGNA	MAGNA	36"
PBR	IPBR	PBR	36"
Loc Seam (12")	n/a	LOC12	36"
Loc Seam (16")	n/a	LOC16	32"



- Inserts into chuck of 14.4 volt or larger A/C or cordless drill
- Clamping device is standard with the Corrugated Metal TurboShear
- 24ga-30ga capacity in steel panels
- Long-life, dual ball bearings
- 360° rotating head secures in any position for optimum tool clearance and material flow
- Ideal for fast cutting in a wide variety of panel profiles
- Malco® brand — Made in USA

**TURBOSHEAR CM**

SKU	Item
TSCM	TurboShear Corrugated Metal
TSCMRB	Replacement Blade



- Aviation style steel metal snips
- Malco® brand — Made in Taiwan

**AVIATION SNIPS**

SKU	Application	Length of Cut	Grip Color
AV6	Cuts Left	1.25"	Red
AV7	Cuts Right	1.25"	Green



- Max 2000 series snips with non-slip, serrated jaws
- Hardened alloy steel blades offer maximum edge life
- Steel handle shaft extends through full length of grip
- Extra long life compression spring
- Ergonomic grip
- Malco® brand — Made in USA

**PREMIUM AVIATION SNIPS**

SKU	Application	Length of Cut	Grip Color
M2001	Cuts Left	1.375"	Red
M2002	Cuts Right	1.375"	Green
M2003	Cuts Straight, Left & Right	1.687"	Yellow

- The serrated upper jaw offers solid gripping power with less burr
- Ground tips on jaws allow access in tight areas
- Has the ability to make nickel size blind hole cuts
- Offset cutting plane makes trim cuts both accessible and efficient
- Steel handle shaft extends through full length of grip
- Extra long life compression spring
- Malco® brand — Made in USA



SKU	Application	Length of Cut	Grip Color
M2006	Cuts Sharp Left Angles, Straight and 5" Circles	1.25"	Red
M2007	Cuts Sharp Right Angles, Straight and 5" Circles	1.25"	Green

## Premium Offset Aviation Snips

- "Andy" aluminum handled 12" snip
- Snug, rounded handle loops that characterized the original
- Lightweight aluminum handle with a snug fit and feel
- Easily replaceable, high-carbon steel blades
- Malco® brand — Made in USA



SKU	Length of Cut	Application	Tool Length	Weight
MC12N	3"	Cuts Straight, Left, Right and 6" Circles	12"	16.7 oz
ULC10	3"	Cuts Straight, Left, and Right	10"	9.5 oz

## COMBINATION SNIPS

- Circular "Duckbill" forged steel snip
- Maneuvers and cuts easily to the very tip of the blade
- Cuts sheet metal, aluminum, steel siding and plastics
- Cuts thin materials without tearing or catching
- Malco® brand — Made in USA



SKU	Length of Cut	Tool Length
MD12	3"	12"

## DUCKBILL STEEL SNIPS

**3 STATION EDGE ROLLER**

- For clean, crisp bends in metal roofing materials
- Quickly adjusts for making bends in a variety of gauges and depths
- Exclusive 3-station roller design produces a uniform bend out to the very ends of a straight panel length
- Center roller station is also independently adjustable for making mild-angled bends on a curve
- Hardened rollers assure long service life
- Malco® brand — Made in USA / Italy

SKU	Capacities in Steel		Bending Depth		Weight
	Min	Max	Min	Max	
ER3	29 ga	22 ga	5/8"	4"	8.5 lbs

**HAND SEAMERS**

- Precise Vee-notched depth graduations on jaws are in 1/4" increments
- Jaws are drop forged, high impact steel
- Hardened steel handles resist abuse
- Powerful compound leverage design
- Tool also features rust resistant nickel plating
- Non-slip vinyl grips with hand stops provide added comfort and resistance to elements
- Malco® brand — Made in USA

SKU	Item	Jaw		Tool Length	Weight
		Depth	Width		
S3	3" Offset	1.25"	3.25"	8"	1.5 lbs
SG11	3" Offset	1.5"	3.375"	8 3/4"	2.9 lbs
S2R	3"	1.25"	3.25"	8 3/4"	1.5 lbs
S6R	6"	1.25"	6"	8 3/4"	1.875 lbs

**DRIP EDGE FOLDING TOOL**

- Makes uniform bends along the drip edge of standing seam panels
- High Leverage, Two Post Handle Design
- Rib-Reinforced Steel Plate Construction
- Malco® brand — Made in USA

SKU	Tool Length	Bending Seam	Bending Capacity
DEFT	24"	1" & 1 1/2"	22 ga
DEFT1	18"	1" & 1 1/2"	22 ga

- Hardened alloy steel blades offer maximum edge life
- Steel handle shaft extends through full length of grip
- Extra long life compression spring
- Ergonomic grip
- Malco® brand — Made in USA



SKU	Tool Length	Weight
C4	9"	1.23 lbs

## DOWNSPOUT CRIMPER

# CAULK GUNS

- Heavy-duty professional model with thumb activated pressure release
- Designed for use with a spouted cartridge
- Powerful ratcheting action minimizes worker fatigue or need to warm caulk up
- User can regulate stroke to fit hand; plus rod may be rotated
- Hand puncture wire folds inside handle
- Malco® brand — Made in Taiwan



SKU	Capacity	Carriage Diameter	Tool Length
CG20	1/10 gal	2"	14"

## HEAVY DUTY CAULK GUN

- Lightweight, flexible caulking gun
- Flat design allows you to store in your tool box
- Large ladder-sized hanging hook
- Handy puncture wire stores along handle
- Malco® brand — Made in Taiwan



SKU	Capacity	Carriage Diameter	Tool Length
CG12	1/10 gal	2"	13.4"

## FLEXIBLE CAULK GUN

**CIRCULAR SAW BLADES**

- Saws through metals quickly and accurately leaving clean, burr-free cuts behind
- Ideal for cutting steel studs, pipe, and sheets for most mild steels under 1/4"
- Durable Triple Chip Grind (TCG) metal cutting tooth design maximizes cutting life and speed
- Laser cut stabilizer vents trap noise and vibration—keeping it cool
- Freud® brand — Made in Italy

SKU	Diameter	Teeth	Arbor
D0748F	7 1/4"	48	5/8 "

**HOLE-IN-ONE SAW**

- One piece arbor and hole saw combination eliminates the need for separate arbor attachments
- 4/6 variable pitch teeth milled into high speed steel edge and micro-welded body
- Shatterproof alloy steel body
- 1 9/16" cutting depth
- Malco® brand — Made in USA

SKU	Size
H11	1 1/16"
HSB	1/4" Pilot Bit

**RECIPROCATING BLADES**

- High speed steel cutting edge welded to a flexible high carbon steel back
- Superior manufacturing process outperforms all others
- Malco® brand — Made in Switzerland

SKU	Length	Application
3MC24	4"	Cuts sheet metal, pipe, and profiles up to 18 ga
4TF14	6"	Cuts all metals including stainless steel over 1/8 "



- Excellent for pre-drilling roof and wall panels
- Cutting tips on both ends
- 135° split point



**DOUBLE ENDED BIT**

SKU	Diameter	Length	Twist Length	Quantity
DE30	.128"	2"	½"	12

- Designed for use in a rotary hammer equipped with an SDS (slotted drive shaft) type chuck
- Can be used for drilling in concrete, block, brick, and soft stone



**1/4" x 4" SDS BIT**

SKU	Diameter	Length
SDSP06100	¼"	4"

- Designed for matched tolerance Wedge Bolt Plus



**WEDGE BITS**

SKU	Diameter	Length
SDSPWB12150	½"	6"
SDSPWB12250	½"	10"
SDSPWB16200	5/8"	8"

- A quick, easy method for drilling through mesh or rebar embedded in concrete
- Designed to fit a standard rotary drill with a ½" Jacobs style chuck



**REBAR CUTTERS**

SKU	Diameter	Length
RBC1212	½"	12"
RBC5812	5/8"	12"

**STEP BIT**

- Double flute design assures penetration of soft and thin materials
- Drill holes without burring or deforming stock
- Perfect for use as a "hole-opening" reamer
- Completely resharpenable
- Malco® brand — Made in Switzerland

SKU	Drilling		
	Minimum	Maximum	Increments
UB3	¼"	¾"	⅛"

**MEASURING TOOLS**

**MAGNETIC TIP TAPE**

- Double-riveted, powerful magnetic tip
- Abrasion-resistant nylon coating
- Rubber-clad housing

SKU	Tape	
	Width	Length
T416M	1"	16'
T425M	1"	25'
T430M	1"	30'

**SAFETY**

**SAFETY GLASSES**

- Hard-coated 100% polycarbonate
- Dual 9.75 base curvature viewing areas for wide unobstructed vision
- Lens blocks more than 99.9% of UV-A and UV-B light

SKU	Style
FORSGC	Clear

## Safety

"Your Metal Panel Manufacturer and Building Supplier!"



- NRR 26 dB
- Corded, washable and reusable



SKU

FOR55991

## REUSABLE EAR PLUGS

## MISCELLANEOUS ITEMS

- Designed with painted screw heads in mind, reducing the risk of marring the paint
- Slightly oversized with rounded corners
- Also work great with unpainted screws



SKU

Size

ND1/4

1/4"

ND5/16

5/16"

ND3/8

3/8 "

## MAGNETIC NUT DRIVERS

- Breathable polyester knit shell
- Unique texture latex coating provides secure grip
- Protects against cuts and abrasions
- No problem picking up nails and washers
- Available in M, L, and XL sizes



SKU

WGLOVE

## WONDER GLOVES

- For use on all steel construction
- Acts as a second pair of hands
- Holds insulation in place
- GRAB STICK is strong enough to help hold metal panels in place



SKU

GRBSTK

## MAGNETIC HOLDING TOOL



- Excellent for making a closed ridge
- Designed for use with our panel profiles, but may be used for many other applications
- Constructed of heavy gauge steel

SKU	Rib Spacing
CRIMPLOC12	12"
CRIMPLOC16	16"
CRIMPMAGNA	8" or 9"

**CRIMP TOOLS**

- Ideal for shearing to length and gable end cuts
- Adjustable angle cuts up to 4:12 pitch
- 24 gauge maximum panel thickness
- For use with our Magna Rib or PBR panel profiles

SKU	Profile
SHEARRENTM	Magna-Rib
SHEARRENTP	PBR

**PORTABLE PANEL SHEARS**

- Portable mechanical seamers for use with our mechanically seamed panel profiles
- Auto-shutoff safety switch

SKU	Panel	Gauge		Power		Weight
		Min	Max	Amps	Volts	
SMRSSX	MI-150	24	26	7	120	35 lbs
SMRSSI	MI-200 / MI-210	22	24	11.5	110	89 lbs

**MECHANICAL SEAMERS**

**MAGNA RIB PROFILE**

- Virtually unbreakable light panels with 100% UV protection
- Retains optical clarity over time
- Custom lengths available (up to 20')
- Will stay tough over a wide temperature range (-40°F to 210°F)
- 10-year limited warranty
- Soft White spreads light and greatly reduces harsh shadows and glare
- Follow installation directions

SKU	Profile	Color	Light Transmission
MPOLYC	Magna Rib	Clear	90%
MPOLY	Magna Rib	Soft White	85%

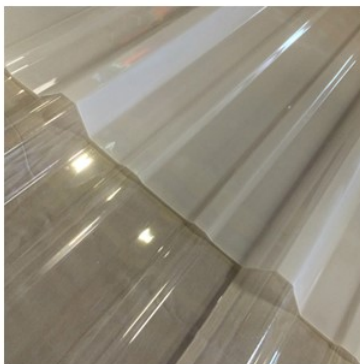
**PBR PROFILE**

- Virtually unbreakable light panels with 100% UV protection
- Retains optical clarity over time
- Custom lengths available (up to 20')
- Will stay tough over a wide temperature range (-40°F to 210°F)
- 10-year limited warranty
- Soft White spreads light and greatly reduces harsh shadows and glare
- Follow installation directions

SKU	Profile	Color	Light Transmission
PPOLY	PBR	Clear	90%
PPOLYW	PBR	Soft White	85%

## CUPOLAS

"Your Metal Panel Manufacturer and Building Supplier!"



- All cupolas are pre-painted 29 gauge steel construction
- Available in over 100 standard colors
- All metal edges are hemmed
- No need to worry about red rust
- Roof and sides interlock for weather tight connection
- Shipped "knock-down", assembles at the job site
- Assembly instructions included
- Premium flashing kit raises the cupola an additional 3 ½" above the peak of the roof, and gives the sides a fuller look from the ground
- Optional weathervane available in a variety of styles



Base Style	Size		SKU	
	Length	Width	Louvers	Windows
Standard	24"	24"	MWCUP24LS	MWCUP24WS
Premium	24"	24"	MWCUP24LP	MWCUP24WP
Universal	24"	24"	MWCUP24LUB	MWCUP24WUB
Standard	36"	36"	MWCUP36LS	MWCUP36WS
Premium	36"	36"	MWCUP36LP	MWCUP36WP
Universal	36"	36"	MWCUP36LUB	MWCUP36WUB
Standard	48"	48"	MWCUP48LS	MWCUP48WS
Premium	48"	48"	MWCUP48LP	MWCUP48WP
Universal	48"	48"	MWCUP48LUB	MWCUP48WUB

## CUPOLAS

## WEATHERVANES

- Weathervanes come standard with black finish
- Please contact us for available styles

SKU	Size
WV24	24"
WV30	30"
WV46	46"



## WEATHERVANES

Included Components			
SKU	Quantity	Size	Description
PSFD	1	24" x 28"	Stall Feed Door
Additional Materials Required (Not Included)			
None			

**Stall Feed Door**

Included Components			
SKU	Quantity	Size	Description
PSD	1	8'	Sidemount Track
	2		Wood Door Trolleys
	1		Sliding Bolt Latch
	1		Small Adjustable Stay Roller
	1		Non-Adjustable Door Stop
	2	8'	Plain Stall Rails
	2	44 1/2"	Punched Stall Rails
	10	30"	Bars
Additional Materials Required (Not Included)			
14	2" x 6" x 4'	Tongue & Groove plus Fasteners	

**4' x 8' Sliding Door Kit**
**AT A GLANCE**

Stall systems and components are designed to meet the needs of horse owners by combining the strengths and flexibility required for safe and easy-to-assemble stall systems. All components are constructed of aluminum to resist rust, corrosion and abuse, and they exceed the industry's highest safety and manufacturing standards. Splintering due to cribbing and chewing is nonexistent because the wall and door edges are framed within an aluminum U-channel which leaves only the flat wood surfaces exposed. Each stall system comes complete with all the pre-fabricated parts and accessories required for quick and easy assembly.

Included Components			
SKU	Quantity	Size	Description
PSP10	2	10'	Punched Stall Rails
	30	30"	Bars
	2	8'	Plain Stall Rails
Additional Materials Required (Not Included)			
14	2" x 6" x 10'	Tongue & Groove plus Fasteners	

**10' Stall Partitions**

Included Components			
SKU	Quantity	Size	Description
PSP12	2	12'	Punched Stall Rails
	35	30"	Bars
	2	8'	Plain Stall Rails
Additional Materials Required (Not Included)			
14	2" x 6" x 12'	Tongue & Groove plus Fasteners	

**12' Stall Partitions**

Included Components			
SKU	Quantity	Size	Description
PSF5	2	5'-7"	Punched Stall Rails
	17	30"	Bars
Additional Materials Required (Not Included)			
14	2" x 6" x 8'	Tongue & Groove	
1	2" x 6" x 10'	Track Board and Fasteners	

**5' - 7" Stall Front**

Included Components			
SKU	Quantity	Size	Description
PSF7	2	7'-7"	Punched Stall Rails
	22	30"	Bars
Additional Materials Required (Not Included)			
14	2" x 6" x 10'	Tongue & Groove	
1	2" x 6" x 12'	Track Board and Fasteners	

**7' - 7" Stall Front**



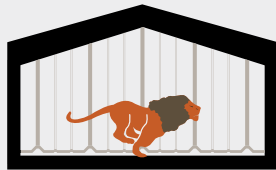

# METALLION INDUSTRIES

850 NW PARK AVE.  
ESTACADA, OR 97023

•  
OFFICE  
( 503 ) 630 - 7740

•  
FAX  
( 503 ) 630 - 7770

•  
[ASKUS@METALLIONINDUSTRIES.COM](mailto:ASKUS@METALLIONINDUSTRIES.COM)

•  
[WWW.METALLIONINDUSTRIES.COM](http://WWW.METALLIONINDUSTRIES.COM)

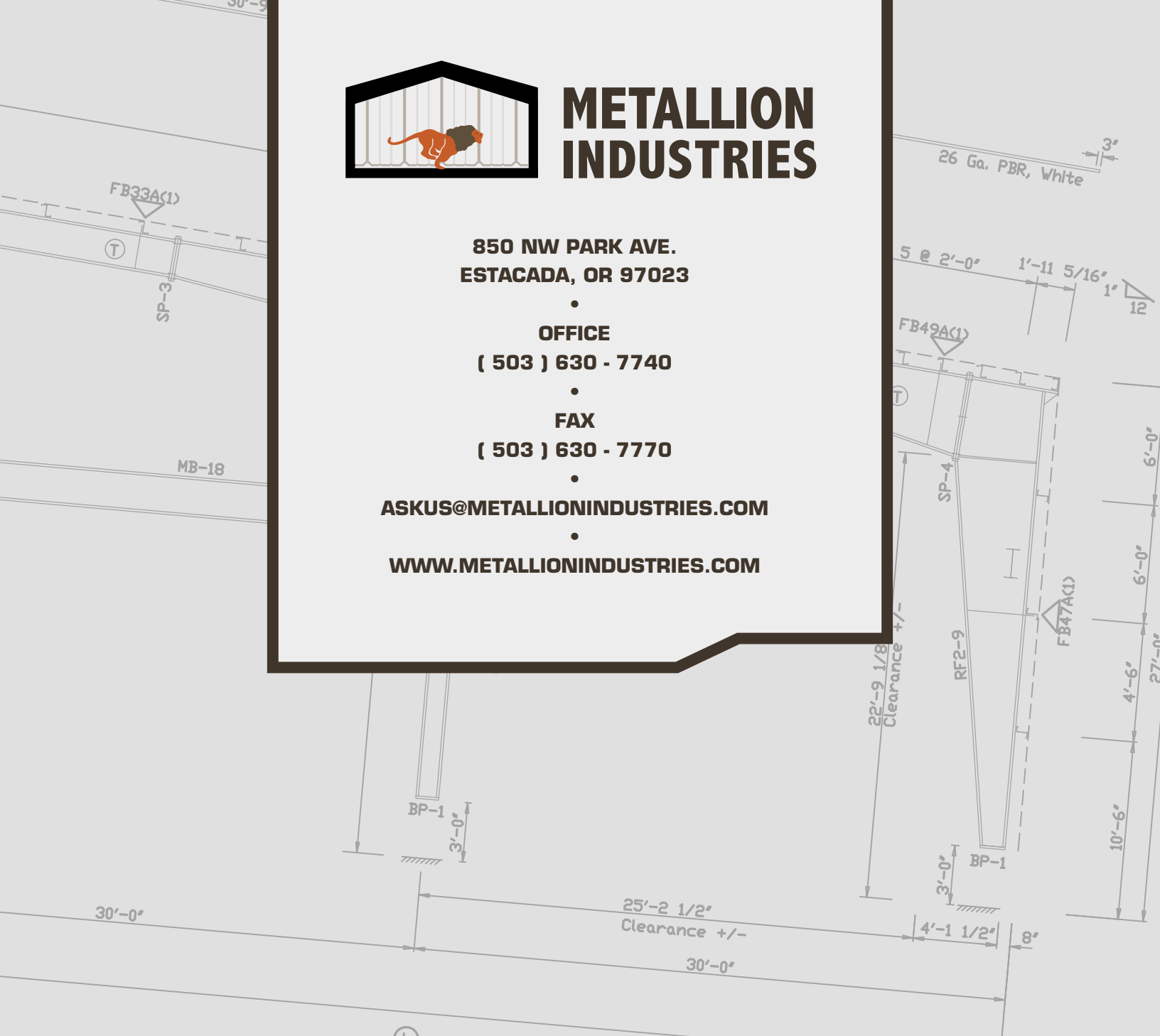

## PRODUCT CATALOG



CUSTOM ENGINEERED STEEL BUILDINGS